

PS2-150 to PS2-4000

Solar Pumping System

Manual for Installation and Operation

Manuel d'installation et de fonctionnement

Manual de Instalación y Operación



EN

FR

ES

LORENTZ 

The Solar Water Pumping Company



ENGLISH

Introduction

Thank you for purchasing a LORENTZ pump system. LORENTZ has set a new standard for quality, efficiency and durability in solar pumping.

Before you begin: All pump systems are equipped with nameplates, which contain all important data. Check the model numbers of all the components of your system, verify that they are the items that you ordered and ensure that the packaging is undamaged and complete. To allow best system performance and to avoid damage read and follow the installation instructions carefully.

How to use this guide: This manual is for system installation only, follow it closely for a safe and durable installation. The system layout must be planned beforehand. We advise using the LORENTZ COMPASS software for correct pump system sizing.

SITES: We highly recommend registering the installation at SITES in LORENTZ partnerNET. SITES provides an easy overview of all installed pump systems, including serial numbers and installation details. This will be essential information should problems occur and will simplify trouble shooting and warranty topics to great extent.

PumpScanner: PumpScanner, the LORENTZ Android™ App, is needed to configure advanced functions and data logging in the PS2. PumpScanner will also assist in the day to day operation of the PS2 controller and add value to your customers.

PumpScanner can be downloaded from the Google Play store, search for LORENTZ PumpScanner. If you do not have access to a Play store in your country, please download the app from www.lorentz.de/psdl.

Important information about use of PumpScanner can be found on page 70.

Further information on use of PumpScanner including detailed functions and installation are available in the PumpScanner manual on partnerNET.



WARNING – Please read the information regarding Password access!

Installation Overview

This installation overview is provided to familiarize you with the typical steps that are taken when installing a solar water pumping system. Your particular installation may require the steps to be done in a different order. You should read the whole manual before making your first installation.



WARNING – Operation of this equipment requires detailed installation and operation instructions provided in the installation/operation manual intended for use with this product. This information is provided in the manual included in the container this device was packaged in. It should be retained with this device at all times. A hard copy of this information may be ordered at www.lorentz.de, where the manufacturer's phone number is provided.

WARNING – This installation overview does not substitute the detailed instructions given in this manual. Read and follow the manual carefully to ensure reliable operation and long life of the product and to avoid danger to health and life.

1. PV and Controller Installation

Please follow manufacturer instructions for PV installation. Every PV installation must be equipped with a PV disconnect switch. Suitable switches are available from LORENTZ.

Please refer to “DC Disconnect Switch” on page 17 for more information on the requirements the PV disconnect must meet.

Install the controller close to the PV array in a shaded location to minimize cable length on the input side.

For detailed information refer to “7.5 Mounting, Space and Ventilation Requirements” on page 19.

2. Electrical Installation

1. Pump wiring: The ECDRIVE must be connected to the terminals L1, L2, L3 and to the earth connector ⊕ below the pcb. Observe rotation direction.

For detailed information refer to “7.6.2 Pump Wiring” on page 26.

2. Accessories wiring: Connect a source low protector to terminals 1 and 2 (required). Remote control switches must be connected to terminals 3 and 4, water meters to terminals 5 and 6, 4–20 mA sensors to terminals 7 and 8 or 9 and 10, water sensors to 13, 14 and 15 and the SunSensor module to terminals 16 and 17. Terminals 11 and 12 are an output relay switch.

For detailed information refer to “7.6.3 Pump Accessories Wiring” on page 27.

3. DC input wiring: Connect the positive terminal of the PV array to +, the negative terminal to –. Observe max. input voltage. If the controller is connected to a battery then battery mode must be activated in PumpScanner.

For detailed information refer to “7.6.4 Input Wiring for Solar-direct Systems” on page 28.

4. Grounding: A protective earth connection must be wired to the earth connector ⊕ below the pcb.

For detailed information refer to “7.6.6 Grounding” on page 30.

3. Pump Installation

Submersible pumps: Lower the pump into the water source with caution, use a safety rope.

For detailed information refer to “8.3 Submersible Pumps” on page 34.

Surface pumps: Install the surface pump on an adequate foundation with sufficient pipe sizing to ensure efficient operation. Fill the pump with clean water prior to starting it.

Depending on your pump system, refer to “8.4 CS-F Surface Pumps” on page 39 or “8.3 Submersible Pumps” on page 34 for detailed information.

1	Declaration of Conformity	6
2	Receipt, Storage and Handling	6
3	Product Specification	7
3.1	General	7
3.2	Features	7
3.3	Approvals / Certification	7
3.4	Naming	8
4	Operating Conditions	9
5	Safety Instructions	10
6	Pump System Sizing & Layout Diagrams	12
6.1	Pump System Sizing	12
6.2	System Layout: Submersible Pumps	13
6.3	System Layout: Surface Pumps	14
6.4	System Layout: Surface Boost Pumps	15
7	Controller Installation	16
7.1	General	16
7.2	Controller Elements	18
7.3	Technical Data of the Controller	18
7.4	Controller Placement	19
7.5	Mounting, Space and Ventilation Requirements	19
7.6	Wiring the Controller	21
7.6.1	Terminal Descriptions	22
7.6.2	Pump Wiring	26
7.6.3	Pump Accessories Wiring	27
7.6.4	Input Wiring for Solar-direct Systems	28
7.6.5	Input Wiring for Battery-based Systems	29
7.6.6	Grounding	30
7.7	PS2 pool pump systems	31
7.8	PS2 boost pump systems	31
8	Pump Installation	32
8.1	General Instructions	32
8.1.1	Pipe Sizing	32
8.1.2	Cable Splicing	33
8.2	Pump System Type	33
8.3	Submersible Pumps	34
8.3.1	Wiring the Pump	34
8.3.2	Installation and Handling	36
8.3.3	Installation Depth	37
8.3.4	Removal	37
8.3.5	Additional Features	38
8.3.5.1	Safety Rope	38
8.3.5.2	Plastic Pipes	38
8.3.5.3	Flow Sleeve	38
8.4	CS-F Surface Pumps	39
8.4.1	Placement and Foundation	39
8.4.2	Pump Motor Wiring	40
8.4.3	Installation and Handling	41

8.4.4	Suction Head	42
8.4.5	Initial Start-up	43
8.4.5.1	Filling Pump with Water	43
8.4.5.2	Rotary Direction	44
8.4.5.3	Final Check-up	44
8.5	Pool Surface Pumps	45
8.5.1	Placement and Foundation	45
8.5.2	Pipe Sizing	46
8.5.3	Installation and Handling	47
8.5.4	Initial start-up.	48
8.5.4.1	Filling Pump with Water	48
8.5.4.2	Rotary Directon	49
8.5.4.3	Final Check-up	49
8.5.5	Service and Maintenance	50
8.5.5.1	General Maintenance	50
8.5.5.2	Cleaning the Strainer	50
8.5.5.3	Use with salt water or sea water	50
8.5.5.4	Replacement of the Mechanical Seal	51
8.6	Boost Surface Pumps	52
8.6.1	Placement and Foundation	52
8.6.2	Pump Motor Wiring	52
8.6.3	Installation Position	53
8.6.4	Filtering	54
8.6.5	Plumbing Design	55
8.6.6	Freeze Protection	56
9	Pump Accessories Installation	57
9.1	Well Probe	57
9.2	Float Switch (Full Tank Shut-off).	59
9.3	Water Meter	60
9.4	Sacrificial Anode	60
9.5	Liquid Level Sensor	61
9.6	Pressure Sensor.	61
9.7	Sun Sensor module	62
9.8	Surge Protector	63
9.9	PV Disconnect with Lightning Surge Protection	63
10	Operating the Pump	64
10.1	LED Status	65
10.2	Starting the Pump	68
10.3	Time Delays.	68
10.4	Parameter Setting.	69
11	PumpScanner / CONNECTED	70
11.1	PumpScanner.	70
11.2	Password Access	70
11.3	PS Communicator & pumpMANAGER.	71
12	Troubleshooting	72
12.1	Pump does not run	72
12.2	Pump attempts a Restart every 120 Seconds	72
12.3	Flow Rate is too low	72
12.4	General checklist	73

1 Declaration of Conformity

We, BERNT LORENTZ GmbH Germany, declare under our sole responsibility that the products

PS2-150 Boost, PS2-150 C, PS2-150 HR, PS2-200 HR, PS2-600 HR, PS2-600 C, PS2-600 CS-F, PS2-600 Pool CS-17-1, PS2-1800 HR, PS2-1800 C, PS2-1800 CS-F, PS2-1800 Pool CS-37-1, PS2-4000 HR, PS2-4000 C, PS2-4000 CS-F

to which the declaration relates, are in conformity with the Council Directives on the approximation of the laws of the EC Member States relating to:

- Machinery (2006/42/EC)
- Electromagnetic compatibility (2014/30/EU)
- Electrical equipment designed for use with certain voltage limits (2014/35/EU)
- Radio Equipment Directive (RED) (2014/53/EU)

BERNT LORENTZ GmbH
Siebenstücken 24
24558 Henstedt-Ulzburg
Germany

1 January 2018



Bernt Lorentz, CEO

2 Receipt, Storage and Handling

Check upon receipt that the packaging is undamaged and complete. If any abnormality is found, contact your supplier.

LORENTZ pumps are supplied from the factory in proper packing in which they should remain until they are to be installed at the site. Handle the pump with care and avoid unnecessary impacts and shocks.

Prolonged intermediate storage in an environment of high humidity and fluctuating temperatures must be avoided. Moisture condensation may damage metal parts. Non-compliance can void the warranty. It is recommended storing the parts in a closed and dry room.

The motor, the pump end and controller can be stored (not used) in the range of $-20\text{ }^{\circ}\text{C}$ to $+65\text{ }^{\circ}\text{C}$ ($-4\text{ }^{\circ}\text{F}$ to $+149\text{ }^{\circ}\text{F}$). The components should not be exposed to direct sunlight.

3 Product Specification

3.1 General

LORENTZ solar submersible and surface pump systems are designed to efficiently deliver high volumes of water running exclusively on solar power. They are typically used in irrigation projects and for wide area drinking water applications where they reliably meet the most demanding requirements, economically, without pollution and without a grid connection or diesel generator.

A typical solar pumping system is composed of a PV generator array, a pump and a solar pump controller. Based on the design philosophy that it is more efficient to store water rather than electricity, there is no energy storing device such as a storage battery in a typical solar pumping system.

The PV generator, an aggregation of PV modules connected in series and in parallel, absorbs solar irradiation and converts it into electrical energy, providing power for the whole system. The pump controller controls and adjusts the system operation and adjusts the output frequency in real-time according to the variation of sunlight intensity to realize the maximum power point tracking (MPPT).

Each LORENTZ pump system consists of a pump end, pump motor and a controller. This modular concept keeps all electronics above ground even for submersible pumps, simplifying servicing and lowering cost of ownership.

3.2 Features

LORENTZ pumps have the following features:

- Engineered in Germany using high quality non-corrodible materials
- IP65/NEMA 3A corrosion resistant controller housing
- Pump control based on power available
- ECDRIVE DC Brushless motors, specifically designed for solar operation with up to 92% efficiency
- Monitoring and management including on-board recording of up to 5 years of performance data, smart device access via PumpScanner Android™ App and integration to LORENTZ pumpMANAGER remote management service optionally available.

3.3 Approvals / Certification

LORENTZ PS2 systems are sold in more than 130 countries. Versions and approvals requirements will vary from country to country. Please see the actual controller labelling to confirm exact version and approvals marking. Full approvals certificates can be found on partnerNET.

3.4 Naming

Pump model definition for submersible pumps:

For centrifugal pumps

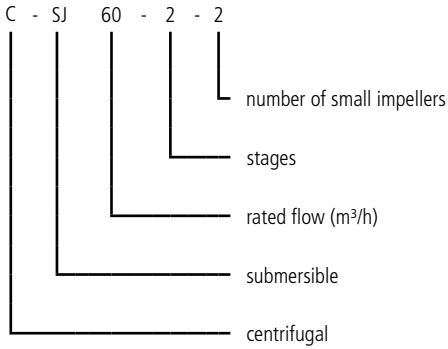

Pump model definition for surface pumps:

For CS-F1 to CS-F20 pumps

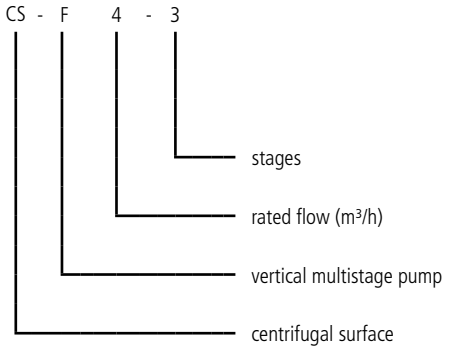

For helical rotor pumps

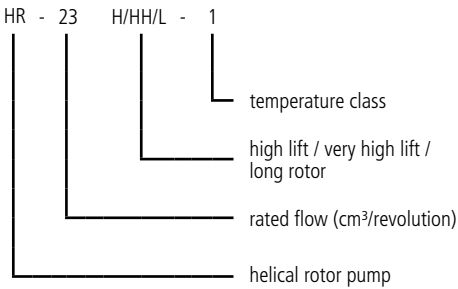

For CS-F32 to CS-F85 pumps

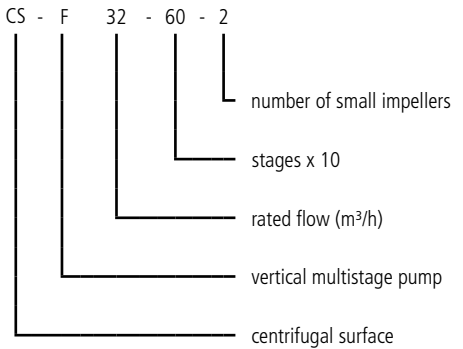

For pool pumps

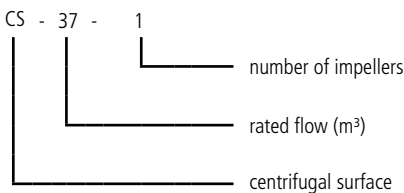

For boost pumps

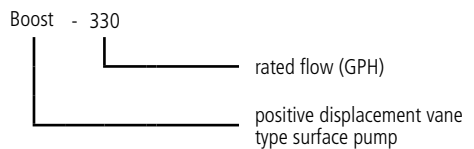

4 Operating Conditions

Ambient requirements: PS2 pump systems can be operated up to 3000 meters above sea level and at an ambient temperature of up to 50 °C. When the temperature reaches the limit the power will be reduced automatically. The PS2 controller is designed for use in environments classified as pollution degree 3 in accordance with IEC-664-1: Conductive pollution occurs, or dry non-conductive pollution, which becomes conductive due to condensation, is to be expected.

Fluid: LORENTZ PS2 Helical Rotor (HR) and Centrifugal pumps can be used for drinking water supply, livestock watering and irrigation applications not containing solid or long fibred particles larger than sand grains, with a max. grain size of 2 mm. The max. permitted sand content is 50 ppm, a higher sand content will reduce the pump life considerably due to wear. The max. salt content is 300-500 ppm at max. 30°C / 85°F. Defects due to pumping other liquids are not covered by the warranty.

LORENTZ PS2 Pool pumps can be used in chloride water, salt water and sea water swimming pools. When used in salt and sea water pools, the pump must be inspected and cleaned regularly.

LORENTZ PS2 BOOST pumps can be used for clean water applications only. The water must not contain any abrasive particles. It is highly recommended to install an intake strainer to protect the pump from any dirt ingress. Please refer to "8.6.4 Filtering" on page 54 for further information.

Fluid temperature: Depending on the type of your LORENTZ pump system, different requirements for fluid temperatures apply:

PS2 centrifugal submersible - The maximum fluid temperature for centrifugal submersible pumps is **+50 °C (122 °F)**.

PS2 centrifugal surface - The maximum fluid temperature for centrifugal surface pumps is **+70 °C (158 °F)**.

PS2 pool pumps - The maximum fluid temperature for pool pumps is **+60 °C (140 °F)**.

PS2 boost surface - The maximum fluid temperature for boost pumps is **+80 °C (176 °F)**.

PS2 helical rotor (HR) submersible - Designing and building helical rotor pumps for a narrow range of fluid temperature is important to ensure the best possible efficiency. LORENTZ PS2 helical rotor pumps are available in five different temperature classes:

Temp. class 0:	0 – +10 °C (32 – 50 °F)
Temp. class 1:	+10 – +20 °C (50 – 68 °F)
Temp. class 2:	+20 – +30 °C (68 – 86 °F)
Temp. class 3:	+30 – +40 °C (86 – 104 °F)
Temp. class 4:	+40 – +50 °C (104 – 122 °F)

The pumps have a tolerance range of ± 2 °C (± 3.6 °F) regarding the respective temperature ranges, except for the lowest allowed temperature of 0 °C.

The temperature class is part of the pump units' name tag, please refer to chapter "3.4 Naming" on page 8. The pump system shall only be operated within the temperature range specified upon ordering.



CAUTION – PS2-200 HR pump ends and pump units must always be ordered with the next higher temperature class, to avoid starting problems in weak irradiation conditions.

CAUTION – Operating the pump outside of the specified temperature range can lead to reduced efficiency and/or damage the pump and can void the warranty.



INFORMATION – Due to the precise tolerances within LORENTZ HR pumps there may be situations where a higher temperature class pump than the actual water temperature is recommended. These recommendations are based on prior experience of local water impurities and particulates within the water.

5 Safety Instructions

Safe operation of this product depends on its correct transportation, installation, operation and maintenance. Failure to follow these instructions can be dangerous to life or health and/or void the warranty.

READ AND FOLLOW ALL INSTRUCTIONS!

Explanation of warning symbols



WARNING – Disregard can lead to injury, death or damage the system.



CAUTION – Recommended to avoid damage, premature ageing of the pump or similar negative consequences.



CAUTION – Hot surface. Indicates that the marked item may be hot and should not be touched .



Refer to the operating instructions

When installing and using this electrical equipment, basic safety precautions should always be followed, including the following:



WARNING – To reduce the risk of injury, do not permit children to use this product unless they are closely supervised at all times.

WARNING – The appliance is not to be used by persons (including children) with reduced physical, sensory or mental capabilities, or lack of experience and knowledge, unless they are instructed and closely supervised.

WARNING – To reduce the risk of electric shock, replace damaged cords immediately.

WARNING – It must be assured that all grounding connections are properly made and that the resistances meet local codes or requirements.

The manual contains basic instructions which must be observed during installation, operation and maintenance. Before installation and start-up, the manual should be carefully read by the person in charge of the installation. The manual should also be read by all other technical personnel/operators and should be available at the installation site at all times.

- **Personnel qualifications and training** – All personnel for the operation, maintenance, inspection and installation must be fully qualified to perform that type of job. Responsibility, competence and the supervision of such personnel must be strictly regulated by the operator. Should the available personnel be lacking the necessary qualification, they must be trained and instructed accordingly. If necessary, the operator may request the manufacturer/supplier to provide such training. Furthermore the operator/user must make sure that the personnel fully understand the contents of the manual.
- **Dangers of ignoring the safety symbols** – Ignoring the safety directions and symbols may pose a danger to humans as well as to the environment and the equipment itself. Non-observance may void the warranty. Non-observance of safety directions and symbols may for example entail the following: Failure of important functions of the equipment/plant; failure of prescribed methods for maintenance and repair; danger to persons through electrical, mechanical and chemical effects; danger to the environment because of leakage of hazardous

- material; danger of damage to equipment and buildings.
- **Safety-oriented operation** – The safety directions contained in the manual, existing national regulations for the prevention of accidents as well as internal guidelines and safety-regulations for the operator and user must be observed at all times.
 - **General safety directions for the operator/user** – If hot or cold equipment parts pose a danger then they must be protected by the operator/user against contact with people. Protective covers for moving parts (e.g. couplings) must not be removed when the equipment is running. Leaks (e.g. at the shaft seal) of hazardous pumping media (e.g. explosive, toxic, hot liquids) must be disposed of in such a way that any danger to personnel and the environment is removed. All government and local regulations must be observed at all times. Any danger to persons from electrical energy must be eliminated by using good installation practices and working to local regulations (e.g. VDE in Germany).
 - **Safety directions for maintenance, inspection and assembly work** – It is the user's responsibility to make sure that all maintenance, inspection and assembly work is performed exclusively by authorized and qualified experts sufficiently informed through careful study of the operating instructions. The accident prevention regulations must be observed. All work on the equipment must be done when it is not operational and ideally electrically isolated. Ensure all power sources and accessories (e.g. float switch) are disconnected when working on the system. Follow all appropriate electrical codes. There are no user-serviceable parts inside the motor or the controller. The sequence for shutting the equipment down is described in the manual and must be strictly observed. Pumps or pump units handling hazardous liquids must be decontaminated. Immediately upon completion of the work, all safety and protective equipment must be restored and activated. Before restarting the equipment, all points contained in chapter "Initial start-up" must be observed.
 - **Authorized changes and manufacturing of spare parts** – Any conversion of or changes to the equipment may only be undertaken after consulting the manufacturer. Original spare parts and accessories authorized by the manufacturer guarantee operational safety. Using non-authorized parts may void any liability on part of the manufacturer. There are no user-serviceable parts inside the motor or the controller.
 - **Unauthorized operation** – The operational safety of the equipment delivered is only guaranteed if the equipment is used in accordance with the directions contained in this manual. Limits stated in the data sheets may not be exceeded under any circumstances.

**RETAIN THESE
INSTRUCTIONS
FOR FUTURE USE!**

6 Pump System Sizing & Layout Diagrams

6.1 Pump System Sizing

To professionally size and install a water pumping system, depending on the pump type and application various variables need to be taken into consideration:

Static head - Vertical height from the dynamic water level to the highest point of water delivery.

Suction head - Vertical height from the water level to the pump inlet where the water level is below the pump inlet.

Pressure losses - Loss of water pressure due to pipe length and friction caused by pipe material and additional pipe line elements like elbows, valves.

For solar water pumping additionally local **irradiation** levels are necessary to calculate the available power during each day and the effect on water output.

To easily manage and consider the different variables, LORENTZ strongly advises to size pump systems with LORENTZ COMPASS, the solar pump planning software.

COMPASS is the LORENTZ tool for designing, planning and specifying solar pump systems. It is available for download to all LORENTZ partners on partnerNET.

COMPASS is a PC-based tool to simply specify solar pumping systems in real time. It is based on NASA weather data and uses precise algorithms for even the most complex calculations.

By selecting the location from a list of more than 250,000 cities, entering the total dynamic head (TDH) and the necessary amount of water per day the software will automatically show suitable pump systems and the necessary size of the PV generator.

For more complex situations COMPASS offers features from suction head calculation to pipe type specific pressure loss calculation.



NOTE – Always ensure the values used for sizing with COMPASS match the conditions on site. Incorrect parameters can lead to a wrong sizing report.

Figure 1: COMPASS sizing

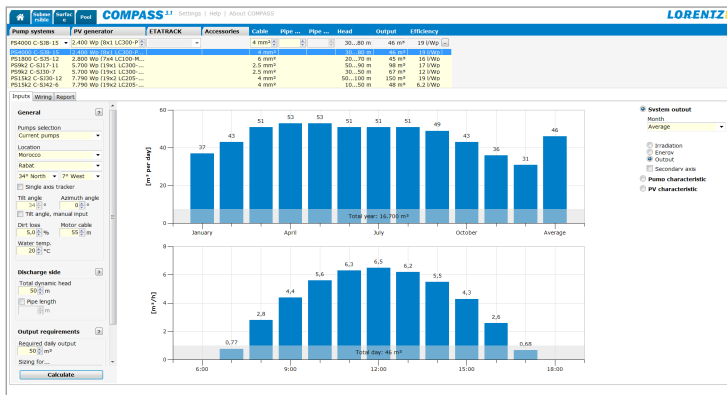

6.2 System Layout: Submersible Pumps



CAUTION – This graphic is an example pump system layout diagram for ease of understanding only. For system installation and wiring read and follow the detailed instructions given in this manual.

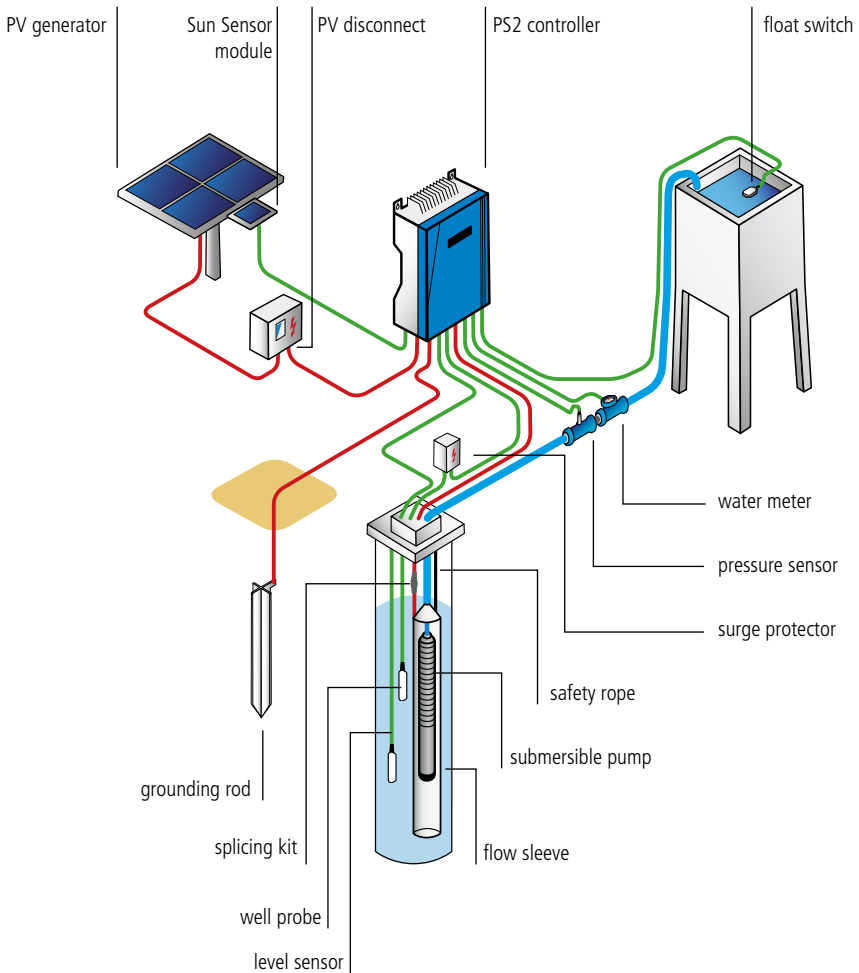

6.3 System Layout: Surface Pumps



CAUTION – This graphic is an example pump system layout diagram for ease of understanding only. For system installation and wiring read and follow the detailed instructions given in this manual.

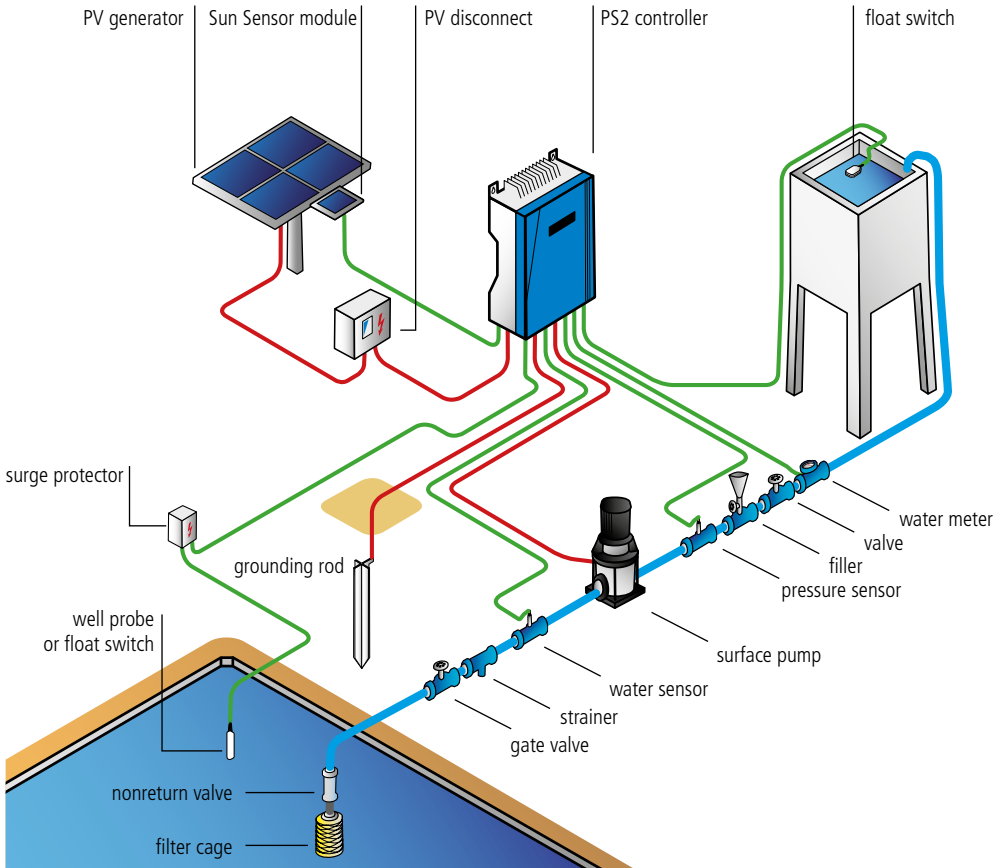

6.4 System Layout: Surface Boost Pumps



CAUTION – This graphic is an example pump system layout diagram for ease of understanding only. For system installation and wiring read and follow the detailed instructions given in this manual.

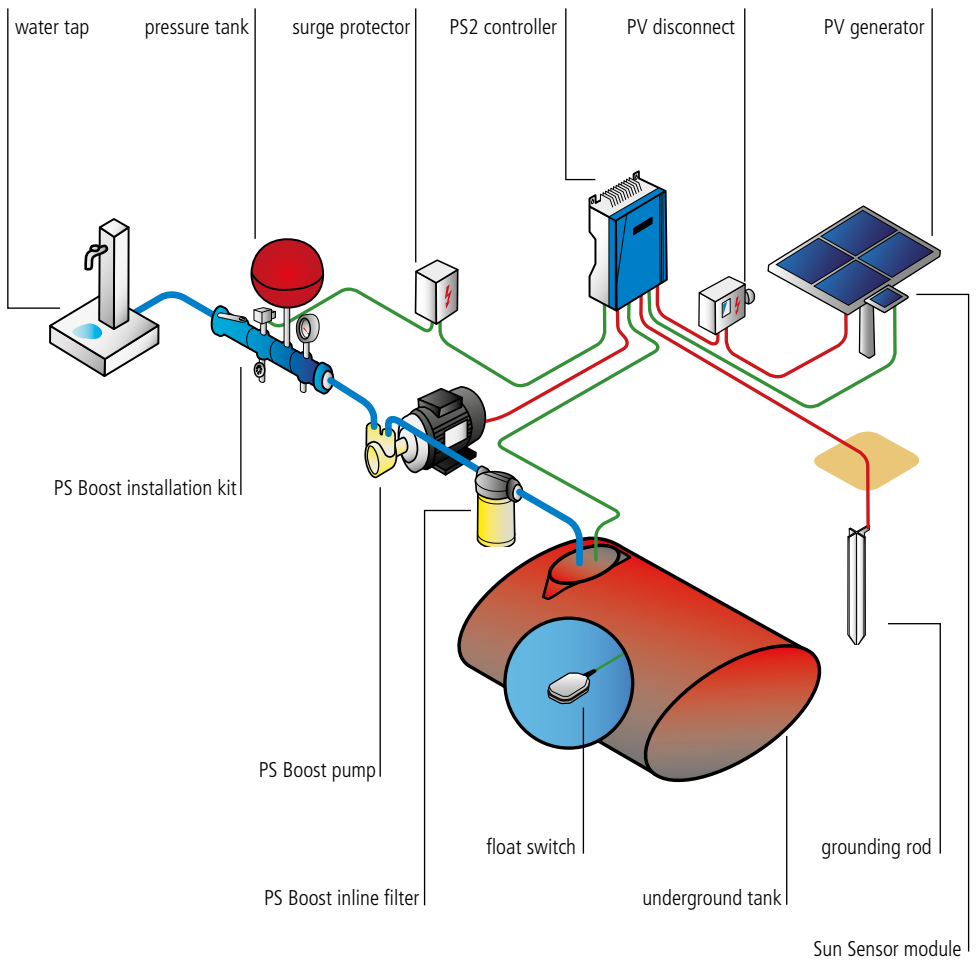

7 Controller Installation

7.1 General



WARNING – All electrical connections must be performed by qualified experts only.

WARNING – Do not dismantle the controller while still connected to the power supply! Before any installation, maintenance or inspection activities wait at least two minutes after the power supply has been disconnected from the controller!



CAUTION – To avoid multiple starts of the pump in twilight conditions, the Sun Sensor module must be connected and configured for all PS2-1800 CS-F and all PS2-4000 pump systems. Operating without a Sun Sensor module can lead to increased wear or damage to the pump. Such damage is excluded from the warranty.

CAUTION – Never let the pump run dry. Dry running will damage the pump and void the warranty. LORENTZ requires a dry run protection for every pump system.

For more information on mandatory accessories and their installation, please refer to “7.6.3 Pump Accessories Wiring” on page 27 and “9 Pump Accessories Installation” on page 57.

Treat the controller as industrial waste when processing the discarded controller. It is possible that some components could produce toxic and harmful gas.

A plug kit is available separately from the controller if plug connectors shall be used.

Figure 2: PS2 controller



DC Disconnect Switch

Every solar pump system **must** be equipped with a properly sized **DC disconnect switch**. The switch must be installed between the PV generator and the controller. It must meet the following requirements:

- minimum rating according to “Table 1: Minimum DC disconnect rating” on page 17
- continuous current rating according to maximum current of the connected PV generator or higher
- the switch must be rated for DC current, **not AC**
- in order to meet UL62109-1 use a minimum 30 A circuit breaker

A PV disconnect switch matching all requirements above can be purchased from LORENTZ.



CAUTION – The use of a properly sized disconnect switch is an important safety measure and obligatory for a professional installation of a solar pump system.

Table 1: Minimum DC disconnect rating

Controller	Min. DC disconnect switch rating
PS2-150	50V DC
PS2-200	100V DC
PS2-600	150V DC
PS2-1800	200V DC
PS2-4000	375V DC

Electrical Conduit

Electrical conduit is recommended. We recommend the use of an electrical conduit (pipe) to protect outdoor wiring from the weather, from human activities and from damage caused by animals. If you do not use a conduit, use a strong, high-quality outdoor cable. Where cables enter the junction box, install sealed strain-relief cable glands.

Wire sizes



CAUTION – In order to meet UL62109-1 the sizing of input and output cable should be 1.25 times higher than sizing with rated current.

For signal cables, the min. wire size should be 1.5 mm² (16 AWG). For power cables, the min. wire size should be 2.5 mm² (14 AWG). Compare your wire sizes to the LORENTZ COMPASS sizing reports. Cables should be shielded to meet EMC the requirement.

For outdoor use, cables meeting the requirements of 60245 IEC 66 are recommended. For indoor use, the recommended cable type is defined in 60245 IEC 57. The installer must always consider the local situation, codes of practice and regulations and use a cable that meets these requirements.

7.2 Controller Elements

- **Power on/off switch** – The power switch is used to start or stop the system and as a reset switch. It does not work as power disconnect switch.
- **Indicator Lights** – The five LED lights on the front indicate different operational situations. For a detailed explanation refer to chapter “10 Operating the Pump” on page 64.

7.3 Technical Data of the Controller

Refer to “Table 2: Technical data of the PS2 controller” on page 18 for an overview of the most important technical specifications of the PS controller.

Technical data of the Bluetooth module:

- Operating frequency: 2402-2480 MHz
- Maximum RF output power: 19.4 dBm

Table 2: Technical data of the PS2 controller

Model	Pump motor: rated power [kW]	Affiliated pump motor	Max. DC input voltage [V]	Min. recommended Vmp [V]	Max.output current [A]
PS2-150 Boost	0.3	ECDRIVE 150-Boost	50	17	22
PS2-150	0.3	ECDRIVE 150-C	50	17	22
PS2-200	0.3	ECDRIVE 200-HR	100	34	11
PS2-600	0.7	ECDRIVE 600-HR ECDRIVE 600-C ECDRIVE 600-CS-F	150	68	13
PS2-1800	1.7	ECDRIVE 1800-HR ECDRIVE 1800-C ECDRIVE 1800-CS-F	200	102	14
PS2-4000	4.0	ECDRIVE 4000-HR ECDRIVE 4000-C ECDRIVE 4000-CS-F	375	238	14

7.4 Controller Placement

The controller must be protected from water, moisture and animals, so keep the controller box sealed. Place the controller in a dry and sufficiently ventilated environment.

Place the controller close to the solar array, not the pump, to reduce the risk of lightning damage. The controllers' input circuitry is more sensitive to surges than its output. Therefore it is safest to minimize the length of the input wiring.

Electronic devices are most reliable when they are protected from heat. Mount the controller where it is shaded from the midday sun. An ideal location is directly under the PV generator. If no shade is available, cut a piece of sheet metal and bolt it behind the top of the controller. Bend it over the controller to provide shade. This is especially important in extremely hot locations. Extreme heat may trigger a thermal function in the controller causing it to reduce the power consumption or turn it off. The controller housing can reach high temperatures when operating at high ambient temperatures. This is normal and will not reduce the expected lifetime of the controller or its components.

7.5 Mounting, Space and Ventilation Requirements

PS2 controllers can be mounted side by side.

For grounding of the front cover the cover screws must be tightened to a minimum torque of 2 Nm.

All PS2 controllers have a fan-less design; they are cooled by air convection. It is strictly advised not to install the controller in an additional enclosure. If an additional enclosure is necessary a sufficient vertical airflow (from bottom to top) has to be ensured to allow sufficient cooling.

PS2 controllers have a keyhole mounting system to simplify mounting on appropriate surfaces. For mounting on poles and similar structures the PS2 is compatible with the LORENTZ PM accessory brackets for a maximum of convenience.

When mounting the PS2 controller with the LORENTZ PM accessory brackets tighten the screws diagonally and evenly.



CAUTION – Do not over tighten the mounting screws on the PS2 housing when using the PM accessory brackets to avoid damage to the PS2 controller housing.

CAUTION – When using PM accessory brackets, for high performance systems and/or with high ambient temperatures a backplate must be installed between the controller and the PM accessory brackets to preserve the funnel effect of the cooling fins. Operating without a backplate can lead to insufficient cooling which will result in reduced performance.

For controller dimensions, cf. "Table 3: PS2 Controller dimensions for installation" on page 20.

Figure 3: PS2 Controller dimensions for installation

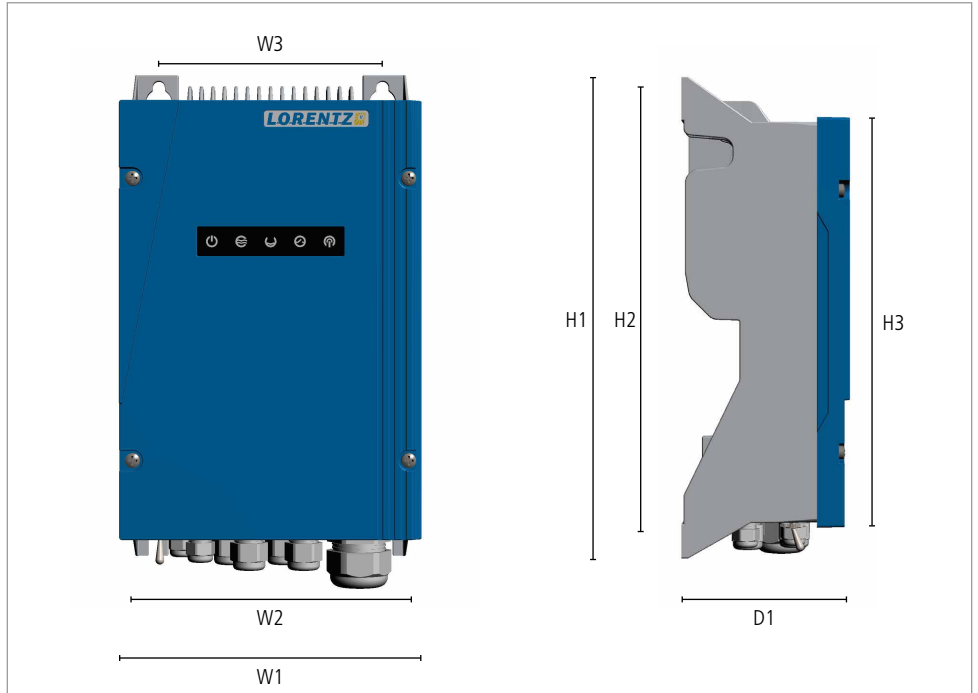

Table 3: PS2 Controller dimensions for installation

Dimension in mm [in]							
W1	W2	W3	H1	H2	H3	D1	Weight in kg [lbs]
207	170	164	352	333	300	124	4.5
[8.15]	[6.69]	[6.46]	[13.86]	[13.11]	[11.81]	[4.88]	[9.9]

7.6 Wiring the Controller



WARNING – All electrical connections must be performed by qualified experts only! Unqualified handling might lead to shock, burns, or death.

WARNING – Beware of high voltage. Never work on a system connected to power or within two minutes after disconnection to avoid electric shock hazard.

Before starting to work on the electrical system make sure that all components are disconnected from the power source. Do not work on any components when power is connected or within two minutes after disconnection. The controller needs time to discharge.

Switch the system on only when all work is completed.



CAUTION – The controller should only be connected to power after correct wiring or the controller might get damaged.

CAUTION – Do not install disconnect switches in the power wires between the motor and pump controller. Connecting the motor wires to a switched-on controller may cause irreparable damage. Such damage is excluded from the warranty.

CAUTION – Solar-direct systems only – Do not connect any electrical load to the PV generator other than the LORENTZ pump controller. Connection of a battery charger, active solar tracker controller, electric fence charger, or other load simultaneously with LORENTZ PS2 systems may interfere with the controller and prevent proper operation.

CAUTION – Measure the voltage before connecting power to the controller. Voltage (open circuit) must not exceed the max. DC input (refer to "Table 2: Technical data of the PS2 controller" on page 18).

7.6.1 Terminal Descriptions

Open the housing by loosening the four screws on the front cover. After removing the cover the terminal can be accessed easily.

For "Power in" and "Motor" open the clamp, insert the wires and lock the clamps in place. Use caution and keep hold of the clamp handles as the terminals contain strong springs. Refer to „Figure 5: "Power in" and "Motor" terminal" on page 23. The length of wire stripping for these terminals is 12 - 13 mm (0.5 in).

For terminals 1 to 17 open the terminal by pushing back the clamp handle with a screw driver, insert the wire, then release the handle to lock the wire in place. Refer to „Figure 6: Terminals 1 – 17" on page 23. The length of wire stripping for these terminals is 5 - 6 mm (0.2 in).

Figure 4: View of open PS2 controller

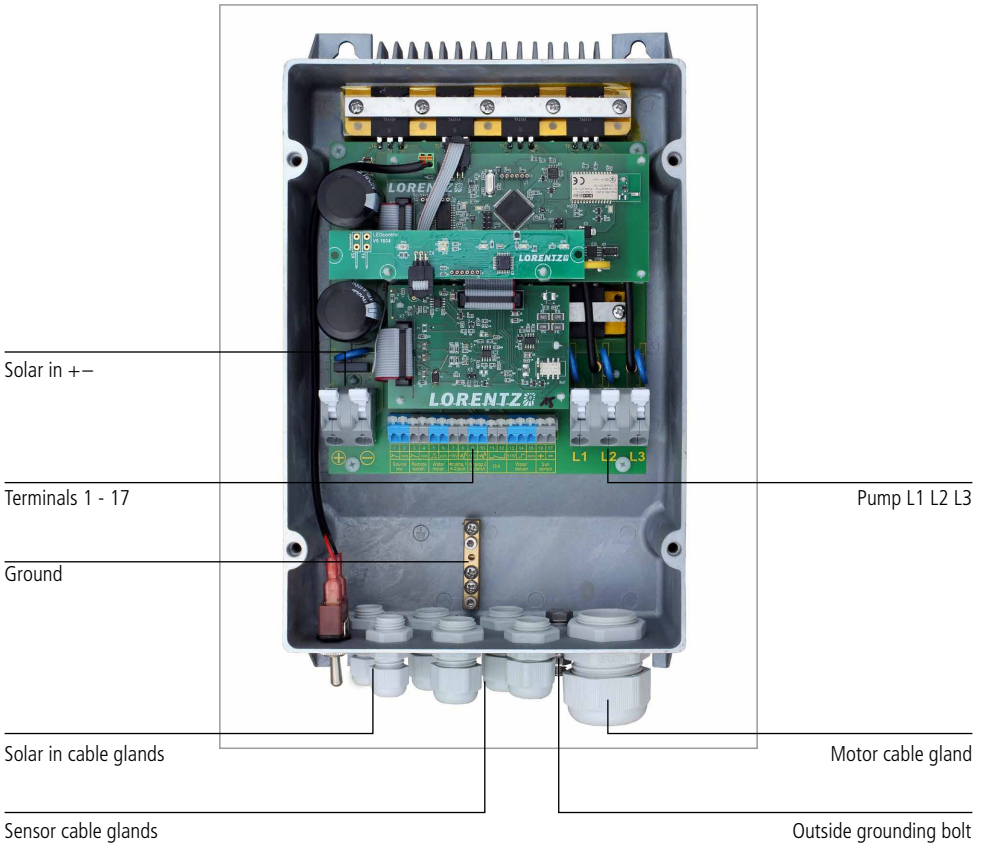

Terminal Description PS2

Figure 5: "Power in" and "Motor" terminal

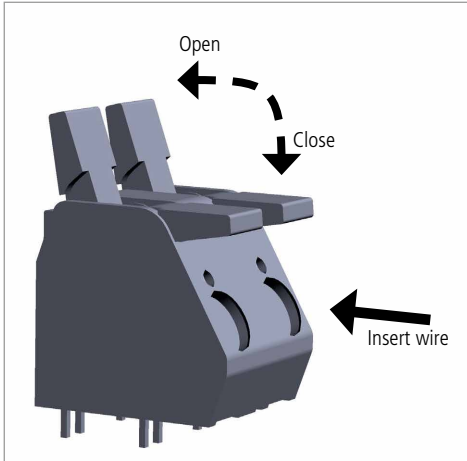

Figure 6: Terminals 1 – 17

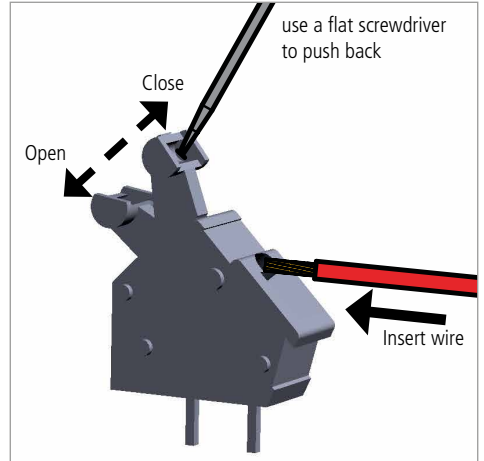
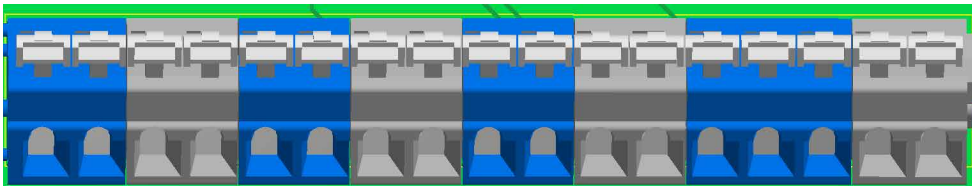

Figure 7: Terminal PS2



1	2	3	4	5	6	7	8	9	10	11	12	13	14	15	16	17
	com		com		com	+24V		+24V				+24V		com	+	-
Well probe		Remote switch		Water meter		Analog 1 4-20mA		Analog 2 4-20mA		Out		Water sensor		Sun Sensor		

Table 4: Terminal explanation

Socket	Terminal	Connection	Function
Power in	+	connect to positive terminal of PV module	Connect the PV array to the controller.
	-	connect to negative terminal of PV module	
Well probe (Source low switch)	1	connect to NC	Connect well probe or float switch to protect the pump system from running dry.
	2	connect to COM	
Remote switch	3	connect to NC	Connect a float switch, pressure switch or any other suitable remote switch. (Factory setting: jumper installed)
	4	connect to COM	
Water meter	5	connect to Imp	Connect a water meter with pulse output. I/imp must be configured with PumpScanner.
	6	connect to COM	
Analog input 1	7	connect to positive (+)	Connect a 4–20 mA signal sensor; supply voltage +24V load; must be configured with PumpScanner.
	8	connect to signal	
Analog input 2	9	connect to positive (+)	Connect a 4–20 mA signal sensor; supply voltage +24V load; must be configured with PumpScanner.
	10	connect to signal	
Out	11		Potential-free signal output to control third party devices; must be configured with PumpScanner.
	12		
Water sensor	13	connect to positive (+)	Connect a water detection sensor for surface pumps. (Factory setting: jumper installed between 14 and 15)
	14	connect to signal	
	15	connect to COM	
Sun Sensor	16	connect to positive (+)	Connect the LORENTZ SunSensor for irradiation based pump control; must be configured with PumpScanner.
	17	connect to negative (-)	
Output to motor	L1	connect to the L1 phase of the motor	Connect the power wires of the LORENTZ pump motor.
	L2	connect to the L2 phase of the motor	
	L3	connect to the L3 phase of the motor	

Terminal Wiring Example

Figure 8: Terminal wiring example

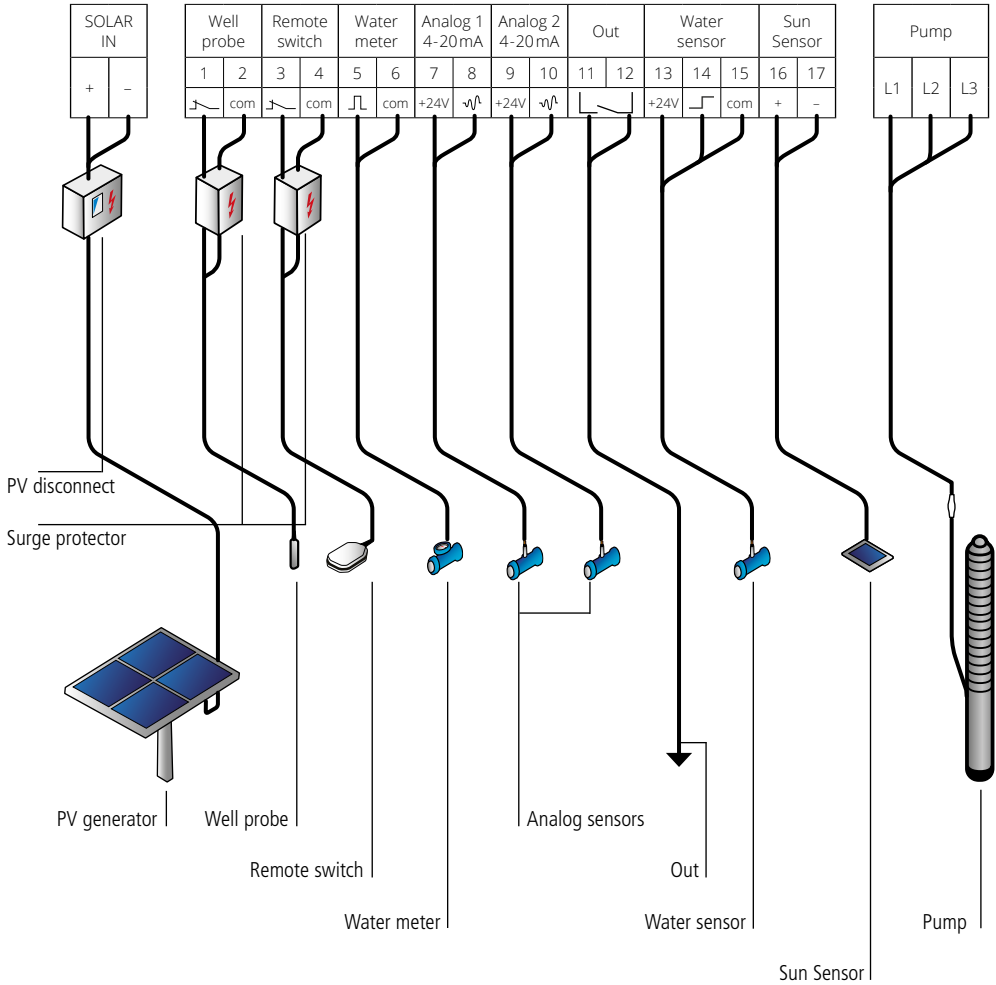

7.6.2 Pump Wiring

The motor cables of the pump have a marking to allow correct wiring. Connect the wires using this sequence:

- 1: Motor cable L1
- 2: Motor cable L2
- 3: Motor cable L3

- Ⓧ: Ground connection

If necessary, interchange any two phases to reverse direction. Refer to chapter “8 Pump Installation” on page 32 for detailed pump installation instructions.

7.6.3 Pump Accessories Wiring

Terminals 1 and 2

To protect the pump from being damaged by dry running connect a suitable source low protection switch to terminal 1 and 2. Every pump system must be equipped with dry run protection. If dry run protection is not needed, add a jumper wire between these two terminals.



CAUTION – Never let the pump run dry. Dry running will damage the pump and void the warranty. LORENTZ requires a dry run protection for every pump system.

Terminals 3 and 4

Connect any kind of external switch for remote control of the controller. To run the pump the switch must be closed (NC). If no switch is used the terminals No. 3 and 4 have to be connected with a jumper cable (factory setting).

Terminals 5 and 6

Install a water meter in the pipeline and connect it to terminal 5 and 6. The output of the water meter must be an impulse signal. The time between two impulses must not exceed 5 minutes. The DataModule can handle up to 10 impulse per second. Select a water meter appropriate for the expected flow. The flow can be viewed with the LORENTZ PumpScanner software.

Terminals 7 and 8/9 and 10

Any suitable sensor for 24 VDC supply voltage, current (signal) range of 4–20 mA and load impedance of 100 Ω can be connected, e.g. LORENTZ pressure sensor, LORENTZ liquid level sensor. The sensor must then be configured in PumpScanner.

Terminals 11 and 12

This is a potential-free signal output contact that can be configured in PumpScanner to control third party devices. It is rated for: 24 VAC, 24 VDC, 1 A.

Terminals 13, 14 and 15

Connect a water sensor to detect the presence of water, this is usually installed on the suction side of surface pumps for dry run protection. If no water sensor is connected a jumper wire must be installed between terminals 14 and 15 (factory setting). The maximum allowed current for sensor supply is 20 mA.

For the installation of a LORENTZ water detection sensor remove the jumper cable between terminals 14 and 15. Connect the sensor to these terminal clamps (the polarity is irrelevant). Other water detection sensors may require a different connection.

Terminals 16 and 17

Connect a LORENTZ 1.5 Wp Sun Sensor module module. This PV module is used to measure the solar irradiation and allows you to set irradiation dependent START / STOP values for the pump. These settings can only be done via LORENTZ PumpScanner.



CAUTION – Only connect a suitable sensor to terminals 7 and 8/9 and 10 / 13, 14 and 15. Never create a short circuit. Observe the polarity of the pressure sensor.

7.6.4 Input Wiring for Solar-direct Systems



WARNING – Beware of high voltage! Electric shock hazard! Hazardous electricity may be present and can shock, burn, or cause death! Authorised, qualified personnel only!

The PV generator can produce hazardous voltage even under low light exposure. To prevent shock hazard while wiring the array, leave one or more wires disconnected or cover the solar array with opaque material.

Table 5: Max. voltage input

Controller	Max. DC input voltage
PS2-150	50 VDC
PS2-200	100 VDC
PS2-600	150 VDC
PS2-1800	200 VDC
PS2-4000	375 VDC



CAUTION – An input voltage higher than specified in “Table 5: Max. voltage input” on page 28 will damage the controller and void the warranty. Damage may occur if the solar generator array is wired incorrectly. Measure the voltage and confirm the polarity before connecting the power to the controller.

Connect the positive terminal of the PV modules to + and the negative terminal of the PV modules to -. Connect the protective ground wire to an appropriate ground system. Refer to “7.6.1 Terminal Descriptions” on page 22 for terminal descriptions and to “7.6.6 Grounding” on page 30 for grounding instructions.

7.6.5 Input Wiring for Battery-based Systems



CAUTION – The PS2-4000 pump system cannot be operated from batteries.

The battery mode for PS2-150 to PS2-1800 controllers must be activated in PumpScanner. This will deactivate the MPP-Tracking function and activate the Low Voltage Disconnect (LVD).

Connect the PS2 controller directly to the battery and NOT to the load terminals of the charger as the terminals may not be rated for the starting load current of the pump. The PS2 controller has a low voltage disconnect function to protect the battery from being deeply discharged.

Some charge controllers monitor the capacity of the battery and regulate the charging accordingly. This method does not work when the PS2 controller is connected to the battery. In order to provide correct charging the charger should be set to voltage orientated regulation. This may require a jumper to be set in the charger. Check the manuals of the charger manufacturer.

Short circuit protection: Install a fuse or circuit breaker near the power source. Use a 30 A circuit breaker or a time delay (slow blow) fuse.

Low-voltage disconnect function: Lead-acid batteries can be permanently damaged by over-discharge when the voltage falls below a critical point. To prevent this, the PS2 battery system controller will turn off at low voltage for at least 20 minutes, and turn back on only after the battery has recovered significantly.

Battery high run mode: If high run mode is activated in PumpScanner, the low voltage disconnect points for 12 V batteries are changed to OFF at 12.3 VDC, ON at 13 VDC.

Table 6: Set points for low voltage disconnect

Controller	Voltage	OFF	ON
PS2-150	12 VDC	11 VDC	12 VDC
	24 VDC	22 VDC	24 VDC
PS2-200	24 VDC	22 VDC	24 VDC
	48 VDC	44 VDC	48 VDC
PS2-600	48 VDC	44 VDC	48 VDC
PS2-1800	96 VDC	88 VDC	96 VDC

7.6.6 Grounding

Before starting to work on the electrical system make sure that all components are disconnected from the power source. Only switch on the system when you have finished all work.

Grounding is mandatory to protect the users from potentially fatal electric shocks. It also protects against electric charging or a short circuit inside the device. This is accomplished through clamping, bolting or other mechanical means to provide an effective grounding path to the earth to ensure safe operation at all time.

The grounding is also important to the system for lightning protection. In general it is meant for indirect lightning strikes and induced electrical potentials during operation of the pump system.

Before installation, contact the local code authorities to determine the necessary grounding requirements.

Insufficient ground source: Where there is an inadequate ground source you can use a grounding rod. A grounding profile rod should be located not more than 4–5 m (13–16 ft) from the controller. The cable must not carry any mechanical loads. The rod must be completely buried in the ground (2.5 m/8 ft below ground level). You must refer to local standards and requirements. The grounding cable should be a copper cable with a cross section of not less than 16 mm² (AWG 6).

A protective earth connection must be linked to the controllers earth connector which is located below the pcb and marked with the protective earthing symbol ⊕. The protective earth wire of the motor must also be connected to the controllers earth connector.

The protective earth connection can also be linked to the grounding bolt on the outside of the controller near the cable glands.

All metallic support structures and electrical enclosures must be grounded.

For grounding of the front cover the cover screws must be tightened to a minimum torque of 2 Nm.

For grounding of the PV generator, follow manufacturer instructions.

7.7 PS2 pool pump systems



NOTE – The following chapter is relevant for PS2 controllers operating pool pumps only.



WARNING – The use of pumps for swimming pools and the restricted area around them is only permitted if pumps are installed in accordance with DIN/VDE 0100 part 702 or other local standards. Please consult your licensed electrician!

WARNING – A cord and plug connected unit shall be provided with a permanently attached flexible cord of a water-resistant type, e.g. SEW, SEOW, SJW, SJOW, SJEW, SJEOW, SJTW, SJTOW, SOW, STW, or STOW. When the pump is connected by cable, use extra-hard type (toughened) cable for connections.

WARNING – When the motor is installed within 1.5 m/5 ft of the inside walls of a swimming pool, spa, or hot tub, a solid-copper bonding-conductor not smaller than 8.4 mm²/AWG 8 must be connected from the accessible wire connector on the motor to all metal parts of the swimming pool, spa, or hot tub structure and to all electrical equipment, metal conduit, and metal piping within 1.5 m/5 ft of the inside walls of the swimming pool, spa, or hot tub.

Before start-up of the pool pump system manually configure the controller to the correct pool pump end with PumpScanner. Please refer to the PumpScanner manual on partnerNET.

7.8 PS2 boost pump systems



NOTE – The following chapter is relevant for PS2-150 controllers operating boost pumps only.

Before start-up of the boost pump system manually set the system to the correct boost pump end with PumpScanner. Please refer to the PumpScanner manual on partnerNET.



CAUTION – starting the boost pump without selecting the correct boost pump end will damage the pump. Such damage is excluded from the warranty.

8 Pump Installation

8.1 General Instructions



WARNING – All electrical connections must be performed by qualified experts only.

WARNING – Before starting any work on the pump/motor, make sure that the electricity supply has been switched off and that it cannot be accidentally switched on!



CAUTION – Before you start the assembly, make sure that all parts were delivered and have not been damaged during transport.

8.1.1 Pipe Sizing

LORENTZ pump systems are extremely efficient. It is important to keep this efficiency throughout the entire system. A main reason for loss of efficiency is pipe pressure losses. Make sure that you have included the pipe pressure losses during the sizing process of your system.

Consider a smart pipeline design from the beginning.



CAUTION – Consult COMPASS or a pipe pressure sizing chart to determine the correct size. Oversize the pipe line to reduce the pressure drop.

CAUTION – The length of the inlet and of the outlet pipeline must be considered for the calculation of the pressure losses

CAUTION – Only run the pump when it is completely prefilled with water (surface pumps), submersible pumps must be completely submerged. This means there must be no air in the pipes.

CAUTION – For surface pumps, air locks must be avoided at the inlet pipe line. Avoid sharp 90° elbows and sharp pipe size adaptors.

8.1.2 Cable Splicing

To connect the motor cable with a cable extension you should connect the cable ends with a splicing kit.

It is very important that the cable joints are fully sealed otherwise moisture could cause a short circuit. This will damage the pump system.

For more information about connecting cable ends with a splicing kit see the "submersible cable splicing" manual in the package of the splicing kit.



CAUTION – Cable splice failures are a common source of errors. Check the splice for proper connections.

CAUTION – Bad cable splicing can damage the controller and/or the pump. Such damage is excluded from the warranty.

8.2 Pump System Type

Depending on your pump system, please refer to the correct chapter for installation instructions:

Pump type	Chapter
Submersible	8.3
Surface CS-F	8.4
Surface Boost	8.3

To determine the type of system you have, please refer to chapter "3.4 Naming" on page 8.

8.3 Submersible Pumps

For submersible pumps only: The ECDRIVES are water lubricated and therefore prefilled with water. If the motor is stored for more than three months, the water will have been pressed out; the rotor must be turned by hand before use to ensure that the rotor is not stuck.

8.3.1 Wiring the Pump



CAUTION – No disconnect switches must be installed between the motor and the pump controller. Connecting the motor wire to the active controller might irreparably damage it. Such damage is excluded from the warranty.

CAUTION – If the pump wires are in the wrong order, the motor will run in reverse and the pump will not function correctly. Damage may result. Check the direction before installing the pump. The proper direction is counter-clockwise when viewed from above.

CAUTION – Never let the pump run dry. Dry running will damage the pump and void the warranty. LORENTZ requires dry run protection for every submersible pump system.

The motor cables of the pump have a marking to allow correct wiring. Connect the wires using this sequence:

- 1: Motor cable L1
- 2: Motor cable L2
- 3: Motor cable L3

- ⊕: Ground connector

The submersible pump must be submerged in water before checking the correct rotational direction. The correct rotation direction for submersible pumps is counter-clockwise, viewed from the top. It is also labelled with an arrow on the pump end.

The testing process for rotational direction depends on the pump type. Please refer to the next page for detailed instructions on testing helical rotor (HR) and centrifugal submersible pumps. To determine which type of pump you have, please refer to "3.4 Naming" on page 8.

Figure 9: Exemplary LORENTZ submersible pumps



HR Pumps:

The HR pumps are positive displacement pumps and hence will only deliver flow rate when running with correct rotation direction. They will be damaged when running in reverse.

A new pump “out-of-the-box” is shipped from the factory with a temporary lubrication film on the rotor which allows a test run of max. 5 seconds in total without submerging the pump. Once the pump came in contact with water the temporary lubrication is gone and the pump must not be operated without being completely submerged! Submerging only the inlet is not sufficient and will result in damage to the pump end.

Check the rotational direction as follows:

- (1) Connect the pump to the controller and power supply.
- (2) Observe the information regarding HR pump testing above and follow them strictly!
- (3) Start the pump and check the rotation direction by observing the motor shaft at the pump inlet.
- (4) Compare to the indicated rotation direction on the pump end.
- (5) In case the direction is wrong, switch off immediately and change two of the three phase leads.
- (6) Start the pump again and check the rotation direction. Do not exceed 5 seconds of combined testing time.
- (7) The pump will only deliver water flow when running with correct rotation direction.

Centrifugal Pumps:

Check the rotational direction as follows:

- (1) Connect the pump to the controller and power supply.
- (2) Start the pump and check the delivered flow rate.
- (3) Stop the pump, disconnect the power supply and change two of the three phase leads.
- (4) Start the pump again and check the delivered flow.
- (5) Stop the pump, disconnect the power supply and compare the flow rates from point 2 and 4. The wiring with the better flow rate has the right rotational direction.

8.3.2 Installation and Handling

To lower the pumps into the borehole, a crane or hoist is recommended, depending on the size and weight of your pump system.

All parts have to be strong enough to withstand the weight of the pump, the motor, the motor cable and the pipe system.

It is also helpful to lower a pump dummy into the borehole before you lower the pump to make sure that the hole is completely free and the pump can slide into the hole without obstructions.



WARNING – Never stand under suspended loads.

WARNING – Always take suitable security precautions (e.g. a strong safety rope) to safeguard the pump against slipping into the well during installation!



CAUTION – Be careful not to bend the pump, take particular care with centrifugal (C) pumps with a high number of stages. Make sure that the pump never stands on the motor cable, that the cable does not get jammed or damaged by sharp ledges or that the cable is not pulled or jerked where it enters the motor.

CAUTION – Helical rotor pumps (“HR pumps”) have an eccentric rotor that causes vibration when the pump is running. This vibration is normal and will not damage the pump. The plumbing equipment such as pipe connectors, riser pipes, etc. must be able to withstand vibrations and should be made of decent quality.

During the process of lowering the pump into the well the motor cable has to be fixed properly to the pipe, see “Figure 10: Fixing of the motor cable at a joint and a straight pipe” on page 36. Where a plastic pipe is used, the longitudinal stretch of the pipe under load has to be considered by leaving a sufficient gap between the pipe and the cable! The cable should be fixed with water-resistant tape. It is a good

installation practice to form a loop with the motor cable near the pump and repeat it about every 40 m / 130 ft along the riser pipe. This will keep any tensile forces away from the motor cable.

To extend the motor cable pay attention to chapter “8.1.2 Cable Splicing” on page 33. Round off the edges of a flange to prevent damage to the cable. Do not fix the cable tightly. Leave space for the pipes to expand. The cable needs to get fixed every 3 m.



NOTE – Measuring and noting down the distances between the fixing will help to lower the pump to the right depth.

Figure 10: Fixing of the motor cable at a joint and a straight pipe

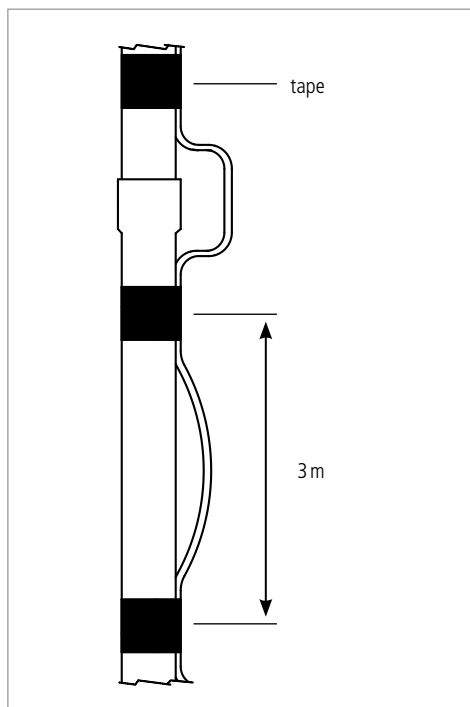

8.3.3 Installation Depth

Make sure that the pump unit is suspended properly and is not in contact with sand and mud from the well bottom. It is recommended to install the pump above the filter zone (= water entry zone) of the well to keep the sand content in the water low and ensure proper cooling of the motor.



CAUTION – The pump must be submerged completely. Never let the pump run dry. Dry running will damage the pump and void the warranty. LORENTZ requires a dry run protection for every pump system.

CAUTION – If the pump does not hang above the filter zone a flow sleeve is necessary.

8.3.4 Removal

If you have to remove the pump system it is the same principle as the installation in reverse order. When removing the pump the pipes will be full of water and will be heavier.



CAUTION – When the pump system is lifted out of the well the pipes are full of water. This causes additional weight.

In the table below you can see the additional weight of the water per meter pipe length.

Table 7: Additional weight per meter pipe length

Pipe diameter	Additional weight	
	[in]	[kg/m]
2	2.0	14.5
2.5	3.2	23.1
3	4.6	33.3
4	8.2	59.3
5	12.7	91.9
6	18.4	133.1

8.3.5 Additional Features

8.3.5.1 Safety Rope

We recommend the use of a safety rope as a loss insurance. If the pipe breaks because of start-up torques of the motor, too much weight, pipe corrosion or wrong installation a safety rope can prevent the total loss of the pump system and damage to the well.

Choose a safety rope that can handle the weight of the whole installation and the water inside the pipes. The rope material must be water-resistant. Near the well head the rope needs to be UV-resistant or protected from sunlight.



CAUTION – Do not use a nylon rope. Nylon is known to absorb water over time which will weaken the rope.

8.3.5.2 Plastic Pipes

When the pipes are strong enough the use of plastic pipes is possible. If you are not sure about the strength of your pipes contact the pipe manufacturer.



CAUTION –The pipes must be strong enough to hold the whole weight of the pump, the motor, the pipe system and the water in the pipes. It must also withstand the water pressure generated by the total dynamic head.

CAUTION – When using plastic pipes you should always use a safety rope.

8.3.5.3 Flow Sleeve

For the maximum recommended sand content, before any significant detrimental effects occur, check chapter “4 Operating Conditions” on page 9.

A higher content will cause excessive wear within the pump and reduce the pump’s life span considerably. Any pump that is blocked by sand will not be covered by warranty.

To reduce the amount of particles entering the pump, a flow sleeve can be installed, see “Figure 11: Flow Sleeve”.

Figure 11: Flow Sleeve

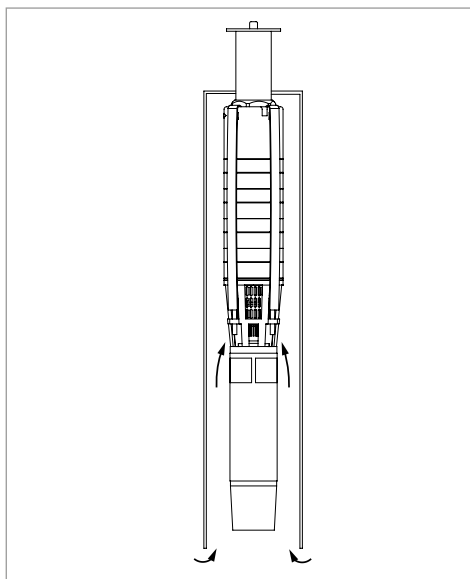

8.4 CS-F Surface Pumps

8.4.1 Placement and Foundation

Rain and weather protection – The pump is equipped with IPX4-type motor protection. If it is installed outside, the pump must be protected from rain and direct sunlight. This will increase the durability of your pump.



CAUTION – CS-F pumps must not be submerged in water or subjected to rain or dripping water.

CAUTION – If the pump is installed in a humid area, effective ventilation and aeration must be provided in order to prevent condensation.

CAUTION – When installing in very small installation spaces the natural cooling may be insufficient. Carefully consider the ventilation in order not to exceed the maximum ambient temperature.

CAUTION – The pump might heat up in operation. The pump must not be installed on combustible surfaces. Strong incombustible surfaces should be used, e.g. concrete or stone surfaces.

Foundation – An arrow on the pump base shows the direction of the flow of the fluid through the pump. It is recommended to install the pump on a concrete foundation. The foundation must be level and should have min. approx. 1.5 times the weight of the pump to absorb vibration, shock and strain.

Connecting the pump to the foundation – Fastening the pump to the foundation should be done exclusively by means of properly sized bolts or threads (dowels) in order to avoid any movement of the pump unit.



CAUTION – The pump must be mounted vertically.

Space – During installation, make sure that there is enough space available to permit subsequent disassembly of the motor unit. It is recommended to have at least 1 m of free space above the pump.

Figure 12: Exemplary LORENTZ surface pumps



8.4.2 Pump Motor Wiring



WARNING – The wiring has to be done by qualified service personnel only.

WARNING – Beware of high voltage!
Electric shock hazard!

The ECDRIVE must be connected to the terminals L1, L2, L3 and the ground connector. The ECDRIVE requires four-conductor (four-wire) cable between the controller and the motor. The three wires L1, L2 and L3 carry power. The fourth wire carries ground. Connect the ground wire to the ground connection below the pcb in the controller. Grounding helps to prevent shock hazard if there is a fault in the motor.

The correct order of the three motor phases is marked on the motor cables itself. Prior to splicing the order of the motor phases should be transferred to the cable. This will simplify the wiring.



CAUTION – No disconnect switches must be installed in power wires between motor and pump controller. Connecting the motor wires to a switched-on controller may cause irreparable damage which is excluded from the warranty.

CAUTION – If the pump wires are in the wrong order, the motor will run in reverse and may damage the pump. Never let the pump run dry, not even for the purpose of checking the direction of rotation.

Check the correct rotation direction after the pump is filled with water, see chapter “8.4.5.2 Rotary Direction” on page 44.

8.4.3 Installation and Handling

Handling – When lifting the pump use the eyebolts at the motor housing. If that is not possible lift the pump at the motor flange by using a holder or straps.

Strainer – If pipelines are welded together metal pieces might be present in the pipeline. Before pump installation, the inlet pipeline must be carefully cleaned. It is recommended to install a strainer about 1 m / 3 ft in front of the pump inlet to avoid pump damage due to any kind of impurities (cp. "Figure 13: Strainer"). The pressure drop of the strainer must be considered in the suction lift calculation.

Pipe system – We advise that pipe expansion joints are used close to the pump on both inlet and outlet to reduce noise and vibration (cp. "Figure 14: Pipe expansion joints"). It is recommended that you install a gate valve in the suction and discharge pipeline close to the pump to avoid draining of the pipe while cleaning (e.g. filters), repairing, servicing or replacing the pump system.

 **WARNING** – Inlet and outlet pipes must be mounted to the pump housing free of tension.

 **CAUTION** – Make sure that the suction pipe is sealed with no leaks, otherwise the pump will not prime or will prime insufficiently.

CAUTION – The pumps are shipped with plastic covers on the pump inlet and outlet. Remove them before connecting the pipes to the pump.

Check valve – A check valve at the inlet pipe is needed to assure that the pump and its suction pipeline remains completely water filled during the time the pump is switched OFF. Always install a check valve with one inch (1") larger diameter than the suction pipe in order to avoid too much suction pressure drop. For example if the suction pipe size is 3", then a 4" check valve should be installed.

Figure 13: Strainer

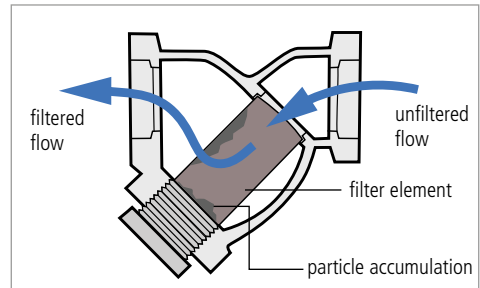
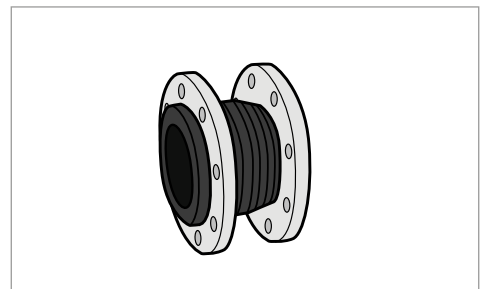

Figure 14: Pipe expansion joints



8.4.4 Suction Head

The maximum suction head is limited by the local air pressure, the water temperature of the medium, the pipe losses and the NPSH value of the pump.



CAUTION – If the suction pressure in the pump is lower than the vapor pressure of the fluid, cavitation will occur. Cavitation creates noise and will damage the pump. Damage due to cavitation is not subject to warranty. To avoid cavitation, the pressure of the fluid must be maintained above its vapor pressure at all points as it passes through the pump.

The maximum suction head (H) must be calculated in advance. The LORENTZ pump sizing software COMPASS can be used for NPSH calculation.

8.4.5 Initial Start-up



CAUTION – Never start the pump if it is not filled with water and has not been vented. The pump and suction pipe must be fully filled with clean water otherwise the pump will be damaged

8.4.5.1 Filling Pump with Water

The pump and the whole suction pipe must be fully filled with clean water.

If the water source level is higher than the pump inlet:

1. Close the gate valve in the outlet pipe and loosen the air vent screw.
2. Open the gate valve in the suction pipe slowly.
3. Tighten the air vent screw when water streams out continuously.

If the water source level is below the pump inlet:

Suction pipeline and pump must be filled with water manually.

1. Close the gate valve in the outlet pipe and open the gate valve in the suction pipeline.
2. Loosen the air vent screw and fill clean water into the pump through the filler pipe.
3. Fasten the air vent screw after the pump and the suction pipeline are completely filled with water.



CAUTION – Installing a suitable filler pipe is highly recommended for proper priming of the pump system. A pump system which is not primed completely will likely get damaged when it is switched on.

CAUTION – A nonreturn valve must be installed at the start of the inlet pipeline otherwise it is impossible to prime the pump successfully.



WARNING – Do not start the pump until it has been filled completely with water.

WARNING – Make sure that the installed shutoff valves in the suction and pressure lines are completely open during operation, the pump must never run with shutoff valves closed!

Figure 15: Vent and drain holes

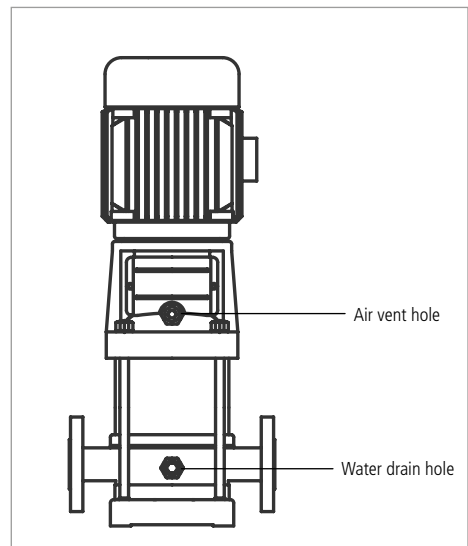

8.4.5.2 Rotary Direction



CAUTION – Never let the pump run dry, not even for the purpose of checking the direction of rotation! Dry running will damage the pump and void the warranty.

Switch on the power supply and look at the rotary direction by looking at the motor fan. An arrow on the pump unit indicates the correct direction of the rotation.

Viewed from the top, the pump turns counterclockwise.

8.4.5.3 Final Check-up

Check whether the foundation bolts are fastened, the pump and suction pipes are completely filled with water, the voltage of the power supply is correct and that the pump turns correctly. Make sure all pipelines are connected tightly and can supply water normally. Make sure there is no closed valve or other obstruction in the water line.

8.5 Pool Surface Pumps

8.5.1 Placement and Foundation



CAUTION – This pump is for use with permanently-installed pools. Do not use with storable/temporary pools.

CAUTION – The drain hole/pipe on the bottom between pump housing and motor must never be clogged or sealed. Blocking the drain hole will result in an internal build-up of water which will damage the motor! Ensure that any drainage cannot cause consequential damage! If necessary provide a suitable drip pan.

CAUTION – If the pump is installed in a humid area, effective ventilation and aeration must be provided, in order to prevent condensation.

CAUTION – The pump must be mounted in horizontal position.



WARNING – The pump might heat up in operation. The pump must not be installed on combustible surfaces. Strong incombustible surfaces should be used, e.g. cement or stone surfaces.

Rain and weather protection – The pump is equipped with IPX4-type motor protection. If it is installed outside, the pump must be protected from rain and direct sunlight. This will increase the durability of your pump.

Foundation – Installing the pump on a concrete foundation is recommended. The foundation must be completely even and level. Its purpose is to absorb vibration and strain in addition to preventing stress on pipe flanges.

Connecting the pump to the foundation – Fastening the pump to the foundation should be done exclusively by means of M8 bolts or threads (dowels) in order to avoid any movement of the pump unit.

Figure 16: Pool Pump



Operating noise – Make sure, by applying appropriate measures, that the local environment will not be impaired by pump operating noise.

Table 8: Operating noise

Pump system	Max. noise level
PS2-600 CS-17-1	65 db
PS2-1800 CS-37-1	68 db

Space – During installation, make sure that there is enough space available to permit subsequent disassembly of the motor unit in the direction of the motor fan (minimum 120 mm / 4.7") and of the strainer basket above (minimum 140 mm / 5.5").

When installing in very small spaces the natural cooling may be insufficient and additional ventilation may be required. Carefully consider the ventilation in order not to exceed the maximum ambient temperature.

8.5.2 Pipe Sizing

LORENTZ pump systems are extremely efficient. It is important to keep this efficiency throughout the entire system. A main reason for loss of efficiency is pipe pressure losses. Make sure that you have allowed for pipe pressure losses during the sizing process of your system.



CAUTION – Consult COMPASS or a pipe pressure sizing chart to determine the correct pipe size. Oversize the pipe line to reduce the pressure drop.

CAUTION – The length of the inlet and of the outlet pipeline must be taken into consideration when calculating pressure losses.

CAUTION – Air locks must be avoided at the inlet pipeline. Avoid sharp 90° elbows and sharp pipe size adaptors.

Figure 17: Prevent air locks in pipes

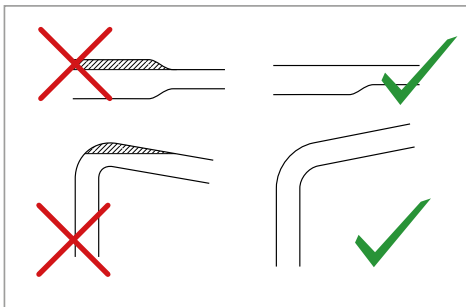
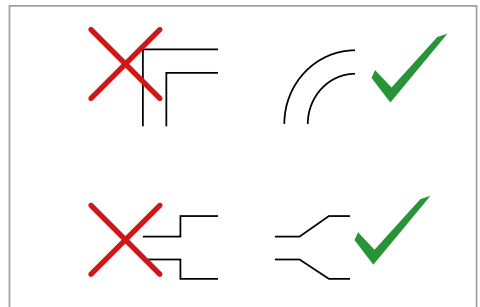

Figure 18: Avoid 90° elbows and size adaptors



8.5.3 Installation and Handling



CAUTION – The pump unit may be installed at either a maximum of 3 m / 9’10” below (gravity feed) or above (suction mode) the water level.

The suction lift may be significantly reduced by flow resistance in the suction line (if the pipes are very long and/or insufficiently dimensioned). The suction/inlet pipe should be as short as possible.



NOTE – Inlet and outlet of PS surface pumps for pools are metric sized. The pumps are supplied with adaptors which are compatible with local market requirements.

When ordering pumps for US/imperial (inch) markets adaptors are provided to connect standard NPS (inch) pipes.

When ordering pumps for metric markets adaptors are provided to allow connection of the next sized up metric pipe. The table below shows the outer pipeline dimensions for the pump inlet and outlet pipe using the supplied adaptors.

Table 9: Nominal pipe size (NPS) and outer dimension (OD)

Model	US/imperial	Metric
CS-17-1	Adaptor provided to connect 2.375" for pipe with NPS 2"	50 mm native connection and adaptor for 63 mm
CS-37-1	Adaptor provided to connect 3.5" for pipe with NPS 3"	63 mm native connection and adaptor for 90 mm

The nominal pipe size (NPS) and the outer dimensions (OD) values are not equal between 1/8 to 12" sizes. For example, the OD of an NPS 2" pipe is actually 2.375". Please pay attention to the actual dimensions of the pool pipework.

Before joining the pipework to the connecting pieces of the housing, the adhesive surfaces must be cleaned completely. Pay attention to the gluing and safety instructions of the adhesive manufacturer.

Pipe system – We advise that pipe expansion joints are used on both sides near to the pump to reduce noise and vibration. It is recommended that you install a gate valve in the suction and discharge pipeline close to the pump to avoid draining of the pipe while cleaning (e.g. filters), repairing, servicing or replacing the pump system.



CAUTION – Inlet and outlet pipes must be mounted to the pump housing in a way that is free of tension.

CAUTION – Make sure that the suction pipe is sealed with no leaks, otherwise the pump will not prime or will prime insufficiently.

Check valve – If the pump is installed above water level a check valve at the bottom of the inlet pipe is needed in order to ensure that the pump and its suction pipeline remain completely water filled during the time the pump is OFF. In order to minimize pressure losses, the check valve should be sized correctly. Always install a check valve which is one inch (1") larger than the suction pipe in order to avoid too much suction pressure drop. For example, with a 3" suction pipe a 4" check valve should be installed.

Strainer – Never operate the pump without having the strainer basket in the pump housing. A full or dirty strainer will impair the flow rate and the filtration. The strainer basket must be regularly emptied and cleaned. Pay attention to chapter „8.5.5.2 Cleaning the Strainer" on page 50.

8.5.4 Initial start-up



CAUTION – Never start the pump if it is not filled with water.

8.5.4.1 Filling Pump with Water

Where the water level is above the pump inlet:

- (1) Close the gate valve of the inlet and outlet pipe.
- (2) Loosen the lid above the strainer basket by turning anticlockwise (i.e. you may use the opening device included in the delivery). Coat the O-ring seal with petroleum jelly, close the lid by hand and make sure that it fits properly (thread is not jammed). Failure to do this will result in the pump not priming correctly.
- (3) Open the gate valve in the inlet and outlet pipe slowly.
- (4) Reopen the lid a little to remove the remaining air below the lid. As soon as water starts to stream out of the lid, tighten it by hand.

Where the water level is below the pump inlet:

- (1) Open the gate valve in the suction pipeline.
- (2) Loosen the lid above the strainer basket by turning anticlockwise (i.e. you may use the opening device included in the delivery). Slowly fill the pump and the suction pipeline with water until the pump housing is completely filled with water. Coat the O-ring seal with petroleum jelly close the lid by hand and make sure that it fits properly (i.e. that the thread is not jammed). Failure to do this will result in the pump not priming correctly.



CAUTION – A check valve must be installed at the beginning of the inlet pipeline.

CAUTION – Do not start the pump until it has been filled with water completely.

8.5.4.2 Rotary Directon



CAUTION – Make sure the pump turns freely, especially after extended periods of down-time. To check this, put a screwdriver into the slot at the fan end and turn by hand in the direction of rotation. If necessary remove fan cover and turn the fan by hand.

CAUTION – Never let the pump run dry, not even for the purpose of checking the direction of rotation!

An arrow on the pump unit indicates the correct direction of rotation. Switch on the power supply and look at the rotary direction by looking at the motor fan. If the direction is wrong, swap over any two of the power wires at the controller.

8.5.4.3 Final Check-up

Check that the foundation bolts are fastened, the strainer basket is installed, the pump is fully filled with water, the voltage of the power supply is correct and that the pump turns correctly. Make sure all pipelines are connected tightly and can supply water normally. Recheck the tight fit of the lid, after the pump has run. Due to suction pressure it might be necessary to retighten it.



CAUTION – Make sure that the installed shut-off valves in the suction (inlet) and pressure (outlet) lines are completely open during operation. The pump must never be allowed to run with shut-off valves closed.

8.5.5 Service and Maintenance

8.5.5.1 General Maintenance

Motor – The motor requires no maintenance. It has no brushes or other frequently wearing parts.



CAUTION – If ball bearings need replacing, bearings with C3 air and high-temperature grease (approx. 180 °C / 360 °F) must be used!

Pump end – The pump mechanism (pump end) is lubricated only by water and requires no maintenance. It may wear after some years, especially if there are abrasive solids in the water. If sand accumulates in the pool or pipes as a result of normal pumping, it is best to take periodic measurement of the pump's performance. A worn pump end can be easily replaced in the field.

If the pump is running with seawater, the pump end must be cleaned periodically. The strainer basket must also be cleaned regularly to avoid excessive salt built-up.

8.5.5.2 Cleaning the Strainer



CAUTION – The strainer basket must be periodically emptied. A full or dirty strainer will impair the pump's flow rate and the filtration.

- (1) Shut down pump
- (2) Close shut-off valves
- (3) Open lid. If this is not possible by hand, use the opening device (included in the delivery). Remove the strainer basket, clean and replace it.
- (4) Close lid
- (5) Open shut-off valves
- (6) Restart pump

8.5.5.3 Use with salt water or sea water

In use, crystallized salt will build up in the pump. The rate of build-up (crystallization) will depend on the concentration of the salt and the temperature of the air and water. In salt water pools, the pump must be inspected and cleaned regularly by removing the drain plug and filter. When the salt deposits cannot be easily cleaned the pool professional must disassemble the pump and clean it. See chapter "8.5.5.4 Replacement of the Mechanical Seal" on page 51 for disassembly instruction.

8.5.5.4 Replacement of the Mechanical Seal

The sealing between the motor and the pump housing is done by means of a mechanical seal. It is normal for a few drops of water to seep in once in a while, especially during the break-in period. Depending on the nature of the water and the duration of operation, the mechanical seal may become leaky after some time. If the water penetrates continuously, replace the complete mechanical seal with a new one. The seals must be replaced by a competent person.

Dismantling – Switch off the pump and disconnect it from the power supply. The mechanical seal always has to be replaced completely. To do so it is not necessary to dismount the complete pump – only the motor unit has to be removed from the housing by loosening the hexagonal socket screws.

Remove the fan cover of the motor by loosening the three screws. Put a screwdriver into the slot of the motor shaft (fan side), hold it and remove the impeller cap screw and the O-ring.



CAUTION – The impeller cap screw (with plastic head) has a left-handed thread. That means the screw must be turned clockwise (top view) to remove it.

The impeller is screwed onto the motor shaft (right-handed thread). Hold the motor shaft with the screw driver (fan side) and unscrew the impeller.



CAUTION – The impeller is secured by LOCTITE 480 (similar to Cyanoacrylate immediate glue).

Carefully lever the mechanical seal out of their fixations with a screwdriver.

Assembly – Apply some petroleum jelly at the edges of the mechanical seal before pressing it in.

Follow these instructions in reverse for reassembly.



CAUTION – Before reassembly clean the surfaces of the components with alcohol or with a clean paper tissue.

8.6 Boost Surface Pumps

8.6.1 Placement and Foundation



WARNING – PS2 Boost pumps must not be submerged in or exposed to other sources of water, e.g. rain.

Operating noises – Make sure, by applying appropriate measures, that the environment will not be impaired by any sound produced by the pump.

Space – During installation, make sure that there is enough space available to permit subsequent disassembly of the motor unit.



WARNING – The pump might heat up in operation. It must be installed on a non flammable surface.

Connecting the pump to the foundation – Fastening the pump to the foundation should be done exclusively by using bolts, threads or dowels in order to avoid blocking the removal of the motor unit.



CAUTION – Inlet- and outlet-pipes must be attached to the pump free of tension.

8.6.2 Pump Motor Wiring

L1 – L2 – L3 – ECDRIVE requires four-conductor (four-wire) cable between the controller and the motor. The three wires L1, L2 and L3 carry power. The fourth wire carries ground. To reverse direction of rotation reverse any two phases.



CAUTION – No disconnect switches must be installed between motor and pump controller. Connecting the motor wire to the switched-on controller can cause damage. Such damage is excluded from the warranty.



CAUTION – Starting the boost pump without setting the controller to boost mode will damage the pump. Such damage is excluded from the warranty.

Figure 19: LORENTZ boost pump



8.6.3 Installation Position

The pump may be mounted horizontally or vertically.



CAUTION – When installing the pump vertically, the pump head must be facing downwards.

Rigid mounting – is not required in most installations. In a non battery system, the pump starts gradually and does not jerk with the start. In a battery system it will jerk slightly, but can be stabilized by mounting it to a small wooden board. The pump may be hung vertically on a rope. Observe the pump to ensure pipes are not overstressed or loosened as it starts.



CAUTION – Do not mount the pump directly to a wall or wood floor in your home. This will increase the noise.

Changing the pump head position – The pumps' fittings can be changed to face sideways or downwards. The pump head may be rotated to a different position by loosening the clamp screws that secure the pump to the motor. Before installing the pump, inject water into the inlet and run the pump.

The pump may be installed either max. 3 m below (gravity feed) or above (suction mode) the water level. Thereby the geodetic head between liquid level and pump inlet must not exceed 3 m. The suction lift may be significantly reduced by flow resistance in the suction line (if the pipes are very long and/or insufficiently dimensioned).

8.6.4 Filtering



CAUTION – This pump needs to be installed with the LORENTZ PS BOOST Inline Filter, even for clear or tap water.

CAUTION – Sand, clay, rust or other solids will cause rapid wear or immediate damage to the pump.

If your water is free of any contamination, the LORENTZ PS Boost inline filter will provide sufficient protection. The use of the LORENTZ intake strainer is recommended as third-party solutions may not be sufficient. Since water conditions can be subject to change, the additional use of a filter is recommended.

A 30 inch intake filter/foot valve is necessary for pumps lowered into wells. For other installations an inline filter is best, installed close to the pumps' intake. If filters are expected to clog often, maintenance may be minimized by plumbing two or more filters in parallel. The inline filter has a clear bowl so its condition may be observed.



CAUTION – Have replacement cartridges ready.

Filter cartridges are available at retailers and local water system suppliers. LORENTZ recommends the use of 10-20 micron "spun polypropylene" type filters. Carbon taste and odor cartridges have less capacity for dirt, more resistance to flow, and are more expensive to use. Use them only if you have taste and odor problems.

A filter cartridge may look clean and still be clogged, due to fine silt embedded in the fibres. If the pump becomes increasingly noisy over time, it is usually due to a clogging filter cartridge. On the other hand a cartridge that looks discoloured may not be clogged. As long as the pump runs quietly, the filter is okay to use. The pump noise is an indicator for the need to change cartridges.

Iron pipes or fittings will introduce abrasive rust particles if installed on the intake side of the pump. Dirt is also introduced as pipe joints are assembled, especially in a trench.



CAUTION – Make sure inlet lines and fittings are flushed clean before attaching them to the pump.

The inline filter may have a red push button valve to release pressure for maintenance. If the filter is placed more than a few feet above the water source (at lowest level) the suction may open the valve and introduce air. Prevent this by sealing the surrounding area of the push button with silicone sealant or epoxy, or replace the button with a nut, tightened down.

8.6.5 Plumbing Design



CAUTION – New pumps are covered with foam plugs to prevent contamination. Remove the foam plugs before connecting pipes.

CAUTION – Handle the pump with caution, never use force on it.

Minimize suction lift – to max. 3 m total pressure loss (2 m for pumps with flow rate greater than 400 l/h (105 US Gal)). The less suction lift, the more reliable and quiet the pump will be. The motor may not be submerged, this will damage the pump.

Intake pipe – The intake pipe may run any reasonable horizontal distance, although it is best to keep it short. Use large pipe for the intake (1 to 1½" for larger booster pumps). Slope the intake line from the water source up towards the pump. Avoid humps in the intake line that cause air pockets which can block the flow.



CAUTION – Avoid leaks in the suction line. The pump will prime insufficiently or not at all.

The intake pipe must be **sized generously** to avoid high pressure drop at peak flow rate, or the pump will be noisy and will wear rapidly.

Use pipe reducer fittings to adapt the pumps' inlet or outlet to larger pipe size where necessary. Larger pipe sizing does not have a negative effect.



CAUTION – The intake must not be restricted by undersized pipe, excessive suction lift, or a clogged filter.

CAUTION – Excessive suction at the pump intake causes cavitation, resulting in noise and rapid pump wear.

CAUTION – Do not use thin wall hose or soft tubing on the pumps' intake. It may collapse under suction and restrict the flow.

CAUTION – Do not use polyethylene pipe for the suction side. It is prone to leakage at the fitting.

Inline filter – Inline filters should be mounted horizontally and as low as possible. This prevents any air trapped from blocking the water flow.

Foot valve – The foot valve is a check valve installed at the water intake. It is required in any situation where the pump is located higher than the lowest water level of the water source. A high quality spring loaded type is recommended to avoid loss of prime. A check valve allows water to flow one way only.

Priming the pump – Priming a pump means completely filling its intake and suction line with water. This must be done if the pump is mounted higher than the water source. A removable plug or a valve must be installed at the highest point in the suction plumbing. Prime the pump and intake line by pouring water into the opening until it is filled completely. Your foot valve prevents loss of prime by not allowing water to flow back into the water source. The pump will create sufficient vacuum to self-prime to around 3 m/10 ft (less at high elevations), but only when it is in new condition and wet inside. A priming plug is always recommended if the pump is installed above the water source. Using a good quality ball valve instead of a plug is recommended, especially if frequent priming is expected.

Check valve at the pump outlet – A check valve at the pump outlet is required if there is more than a 10 m/30 ft lift above the pump, or in any pressurizing system. This allows a more easy start of the pump. It also prevents back flow when changing filter cartridges.

Pipe unions – If you run rigid piping (copper or PVC) directly to the pump, unions are required. Unions make pump replacement easy, without the need to cut and re-solder or re-glue the pipe. "Copper Flex Connectors" commonly used for water heaters may be used instead.

Figure 20: LORENTZ boost pump installation kit

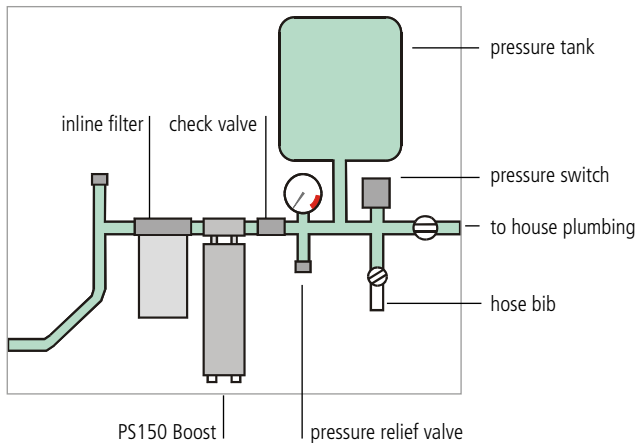

8.6.6 Freeze Protection



CAUTION – The pump must be protected from freezing. Freezing may damage the pump.

CAUTION – When insulating the pump for freeze protection the motor must be excluded to prevent overheating.

9 Pump Accessories Installation



CAUTION – To avoid multiple starts of the pump in twilight conditions, the Sun Sensor module must be installed and configured for all PS2-1800 CS-F and all PS2-4000 pump systems. Operating without a Sun Sensor module can lead to increased wear or damage to the pump. Such damage is excluded from the warranty.

CAUTION – Never let the pump run dry. Dry running will damage the pump and void the warranty. LORENTZ requires a dry run protection for every pump system.

CAUTION – Installing a surge protector at all switch inputs is recommended, damaged inputs due to electric surges are not covered by the warranty.

9.1 Well Probe

The well probe contains a mechanical float with a magnet inside. When the probe is submerged, the float rises, and the magnet actuates a switch. The switch closes (makes contact) to indicate the presence of water. If the water level drops below the probe, the float drops, and the switch opens (breaks contact): The controller will stop the pump. When the water level recovers and the switch closes again, the controller will delay the restart for 15 minutes for the water level to recover. To force a quick restart, turn the controller off, then on again. The switch is sealed, so the contacts never touch the water.

Submersion depth – The maximum submersion depth is 50 meters.

Fixing – Along with the probe two cable ties are provided. For a pump that is to be installed in a vertical position, clamp the probe to the pipe just above the pump outlet, as shown in “Figure 21: Well probe fixing”. Splice the two wires of the probe using the splice kit components that are packed with the probe. The assembly procedure is the same as the main pump splice.

Wiring to the controller – The well probe must be wired to the controller at terminal 1 and 2, cf. “7.6.3 Pump Accessories Wiring” on page 27.

Potential problems with the well probe in surface water – The probe has a moving float. It is highly resistant to deposits and debris. However, the float can become stuck where algae or water creatures are present in surface water.

Figure 21: Well probe fixing



Possible solutions are:

- Fix the probe independently of the pump and pipe (clamped to a weight, but not to the drop pipe). This way, it can be pulled out for inspection or cleaning without the need to lift the pump. (This may not be feasible if the well casing is smaller than 6 in)
- Pull the probe out periodically (with the pump, if necessary) for testing and inspection. The pump should stop a few seconds after the probe leaves the water.
- Wrap the probe in a protective screen (fiberglass window screen, for example).
- Use a different type of float switch. You can use any switch that makes contact on rise (normally open).
- Use an encapsulated switch instead of the well probe if there is enough space for it to operate properly, for example the LORENTZ float switch.



CAUTION – Never let the pump run dry. Dry running will damage the pump and void the warranty. LORENTZ requires a dry run protection for every pump system.

CAUTION – The well probe must be positioned vertically, within 10°. If the pump is not to be installed vertically, find an alternative way to mount or suspend the probe, so that it is located higher than the pump, and in a vertical position.

9.2 Float Switch (Full Tank Shut-off)

We recommend the use of a float switch or other means to prevent overflow of your tank. This will stop the pump when the tank is full, then reset when the level drops. This conserves ground water, prevents overflow, and eliminates unnecessary pump wear. PS2 controllers allow the use of a small signal cable to a remote float switch, even if the tank is a long distance away.

Float switch requirements:

- (1) A switch must be used, not wet electrodes.
- (2) The preferred system requires a float switch to OPEN contact on rise to turn the pump OFF. This is called "normally closed" (N.C.).

Float switch cable requirements:

- (3) Two wires are needed.
- (4) Minimum wire size 1 mm²/AWG 18. This is good for a distance as far as 600 m / 2,000 ft.
- (5) The cable must be suitable for its environment.
- (6) If it must run a long distance, use twisted-pair shielded cable to reduce the chance of damage from lightning-induced surge.

Grounding shielded float switch cable – If you use shielded cable, connect the shield to ground at the controller only. Do not ground the shield at the float switch. This will reduce surges induced by nearby lightning.

Operation of the float switch system – When the water level is high, the float switch will stop the pump. The remote switch indicator on the controller will light up. When the water level drops, the float switch will signal this to the controller. The indicator light will turn off, and the pump will restart if sufficient power is available.

Wiring to the controller – The float switch must be wired to the controller at terminal 3 and 4, cf. "7.6.3 Pump Accessories Wiring" on page 27.

Manual remote control switch – The float switch circuit can be used with a manual switch to turn the pump on and off from a distance. Use any simple on/off switch available from an electronic supply, electrical supply, or hardware store (it only carries low voltage, very low current). Wire it according to the illustration above, for a normally closed float switch.

Figure 22: Float switch scheme

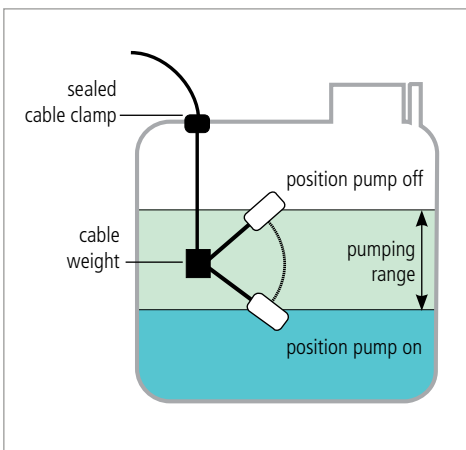

9.3 Water Meter

For information on the water meter installation, please refer to the manufactures manual. Pay attention to the installation position, flow direction and the calming section.

Basic rule: The water meter should have 10 nominal diameters straight pipe ahead of the meter and 5 nominal straight pipe diameters after to ensure proper flow through the meter

9.4 Sacrificial Anode

The LORENTZ Sacrificial Anode is designed for use with LORENTZ pump ends. Where solar pump ends operate in aggressive water conditions acidic water can attacks the passive layer of the high quality-steel pump end. This corrosion reduces the life time of the product. The LORENTZ Sacrificial Anode contributes to the protection of the pump system from this type of corrosion and extends the pumps life.

For further information about the Sacrificial Anode please refer to the COMPASS datasheet.

Figure 23: LORENTZ Water Meter



Figure 24: LORENTZ Sacrificial Anode



9.5 Liquid Level Sensor

The LORENTZ range of liquid level sensors use pressure to measure the level of water in a well or tank. The sensors can be used for long term water level monitoring and also for pump control in applications where a well probe cannot be used.

For further information about the Level sensor please refer to the COMPASS datasheet.

9.6 Pressure Sensor

The LORENTZ range of liquid pressure sensors are used to measure the pressure in a pipe. The sensors are commonly used to measure the pressure at a well head or feeding into irrigation systems.

For more information about the pressure sensor please refer to the COMPASS datasheet. Ensure that the pressure sensor is suitable for your application regarding pressure range and temperature resistance.

Figure 25: LORENTZ Liquid Level Sensor



Figure 26: LORENTZ Pressure Sensor



9.7 Sun Sensor module



CAUTION – To avoid multiple starts of the pump in twilight conditions, the Sun Sensor module must be installed and configured for all PS2-1800 CS-F and all PS2-4000 pump systems. Operating without a Sun Sensor module can lead to increased wear or damage to the pump. Such damage is excluded from the warranty.

The LORENTZ Sun Sensor module allows an irradiation level to be set at which the pump is switched on. This means the Sun Sensor module will not allow the pump to start until there is sufficient irradiation to power the pump to the point of water delivery.

The PS2-1800 and PS2-4000 controllers are supplied with a special small 1.5 Wp PV module (pre-wired for crimping). This PV module is used to measure the solar irradiation and allows you to set irradiation dependent START / STOP values for the pump.

These settings can only be done via LORENTZ PumpScanner. (Please check LORENTZ partnerNET and the "PS DataModule and PumpScanner" manual).

Correct Sun Sensor module settings are given in the COMPASS report, subject to correct parameters. These settings must be checked on site to make sure that the parameters entered in COMPASS match the conditions on site and that the Sun Sensor module is working as intended.

Mount the Sun Sensor module with the same alignment as the solar array that powers the pump system. For example, if the solar array is tilted at an angle of 20°, the PV panel for the Sun Sensor module should be tilted exactly the same. You can ensure this by mounting the PV module on the frame of the PV module array.



CAUTION – Do not use any other PV module than the one available from LORENTZ or the PS2 controller will be damaged.

CAUTION – Voltage reversal of the Sun Sensor module will lead to damage of the controller.

Figure 27: LORENTZ Sun Sensor module



9.8 Surge Protector



CAUTION – Installing a surge protector at all well probe and remote switch sensor inputs is recommended, damaged inputs due to electric surges are not covered by the warranty.

CAUTION – Surge protectors provide an extended protection, not a guaranteed safety. Damages caused by electric surges are not covered by warranty.

CAUTION – When installing surge protectors, correct polarity must be ensured.

Surge protectors are designed to protect electrical devices from voltage spikes. The surge protectors are to be connected in series to the sensor/input, ideally within the PS controller case. It can only be used for well probe, remote switch and water meter terminals. It can not be used for analog input 1, 2, water sensor and the relay output. For more information on the surge protector please refer to the datasheet in COMPASS.

9.9 PV Disconnect with Lightning Surge Protection

The LORENTZ PV Disconnect series is a PV connection box with an integrated disconnect switch and optional integrated lightning surge protector. The box is designed to connect one PV module string (6 strings for the 440-40-6) with the pump controller by using the terminal clamps located inside the box. The DC-rated disconnect switch is used as a manual circuit breaker between the solar array and the load. This switch is easily accessible by opening the hinged lid at the bottom spring lock.

The use of a properly sized DC disconnect switch is an important safety measure and obligatory for a professional installation of a solar pumping system. The switch must be installed between the solar generator and the pump controller. It must meet the electrical requirements of the connected devices. The PV Disconnect has been designed to cover the range of PS pump systems PS2-150 to PS2-4000.

Optionally a lightning surge protection device can be purchased from LORENTZ that fits into a pre-built hole of the PV Disconnect. It requires proper grounding to fulfil its protective function. There are a number of different devices available to suit the voltage level of each controller type.

For more information on installing the PV Disconnect please refer to the PV Disconnect manual.

Figure 28: Surge Protector



Figure 29: PV Disconnect with surge protection



10 Operating the Pump

This graphic displays the front LED indicators of the PS2 controller. For a detailed description of the LED status indication please refer to „10.1 LED Status“ on page 65.



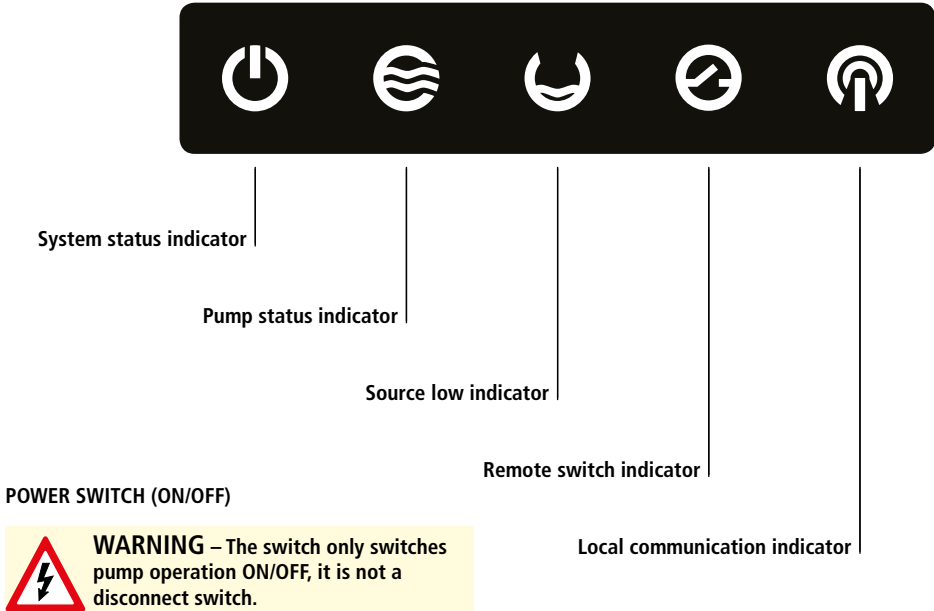

The on/off switch is located at the bottom of the controller.

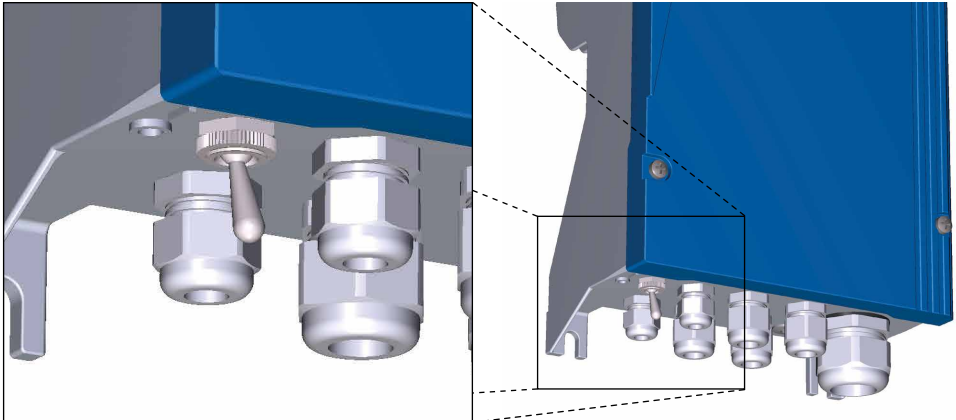

When switched OFF/ON during operation, it resets the system.



10.1 LED Status

	System status of controller	green light	Power is present, ON/OFF switch is in ON position
		green light flashing	Pump in standby mode due to settings or ON/OFF switch in OFF position
		no light	Insufficient power input
	Pump status indicator	green light	Pump is on
		green light flashing	Flashing frequency indicates pump rpm
		no light	Pump is not running
		red light	Check with PumpScanner
	Source low indicator	red light	Well probe or water sensor has detected a low water source
		red light flashing	Flashing indicates a "source low" incident since the controller was switched on
		no light	Water source is okay
	Remote switch indicator	red light	Remote switch triggered, pump stopped
		no light	Remote switch not triggered
	Local communication	blue light	Bluetooth connection active
		blue light flashing	Update
		no light	Currently no Bluetooth connection

Status Description

- **System (green)** – The controller is switched on and power is available. In low-power conditions, the light may show even if there is not enough power to run the pump.
Flashing indicates the pump is not running due to settings, e.g. a timer set up with PumpScanner or the power switch is in OFF position.
- **Pump (green)** – Pump is running. The sequence of flashing indicates pump speed (RPM). RPM can be read off by the flashing sequence of the Pump ON LED:

	RPM
LED On	> 900
1 flash	> 1200
2 flashes	> 1600
3 flashes	> 2000
4 flashes	> 2400
5 flashes	> 2800

- **Pump (red)** – An error has occurred, please check with PumpScanner for details.
Flashing indicates that the controller’s thermal protection was triggered due to a too high temperature. The controller has reduced the motor speed or stopped the pump. It will automatically speed up or restart after cooling down.
- **Source low (red)** – The water source has dropped below the level of the low-water probe or the water sensor has detected air in the suction pipe. After the water level recovers or the suction pipe has been refilled with water, the pump will restart after a delay of 15 minutes. Flashing indicates that the controller has stopped due to a “SOURCE LOW” incident detected earlier. The number of flashes indicates the number of incidents (up to three). Toggle the ON/OFF switch to reset this indicator.
- **Remote switch (red)** – A pump shutdown was triggered by the remote switch wired to terminals 3 and 4.

Controller boot-up sequence

When switching on the power the controller initializes the following LED boot sequence:

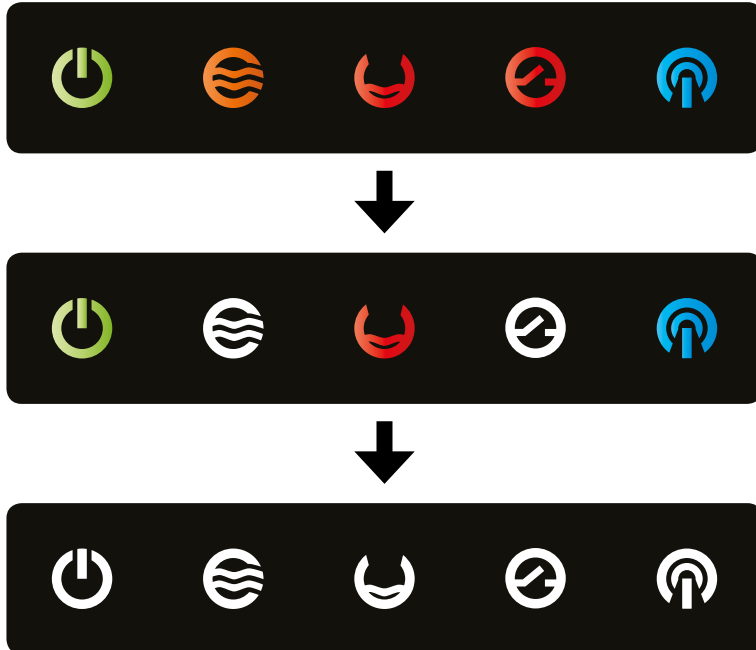

Factory reset

After starting the factory reset from PumpScanner all data will be deleted from the controller. This process takes approximately one minute. During that time the controller shows the following LED status and must not be switched off:



Periodically flashing LEDs

During dawn, dusk and on foggy days the LEDs of the controller may start flashing periodically. This means that the controller tries to boot up but is interrupted due to low PV module power output. The controller will resume normal operation once the power output of the connected PV modules is sufficient to supply the controller.

10.2 Starting the Pump

- (1) Make sure that an unhindered water flow is possible and not blocked, e.g. by closed valves.
- (2) Switch on the PV generator disconnect switch.
- (3) Toggle the power switch on the controller to ON. A solar-direct pump will now start when sufficient irradiation levels are reached and neither the well probe, remote switch or a PumpScanner setting prevent the controller from starting the pump.

10.3 Time Delays

Event	Time delay
Pump stops due to insufficient irradiation	120 seconds
Remote switch resets	2 - 3 seconds
Low water well probe regains contact with water	15 Minutes
Shutdown due to overtemperature	Automatic restart after cooling down
Shutdown due to overload	Manual reset of POWER switch necessary

To force a quick start, the above listed delays can be bypassed by switching the POWER switch OFF/ON. The pump should now start immediately if sufficient power is present.

10.4 Parameter Setting



NOTE – Please always refer to the PumpScanner documentation available on partnerNET for the latest developments.

It is highly recommended to make an initial configuration of the DataModule inside the PS2 controller using LORENTZ PumpScanner, our Application for Android smartphones.

For optimal performance the pump system must be configured correctly with PumpScanner.

To gain access to the DataModule using PumpScanner, the installation must be registered online in partnerNET at "Sites" first. The "License list" within PumpScanner settings then must be updated.

For detailed instructions on how to set up a "Site" and how to install and use PumpScanner read the "PS Datamodule and PumpScanner" manual. It is available on partnerNET.



NOTE – Always make sure that the latest version of PumpScanner is installed on your device. Make sure that the DataModule is equipped with the latest firmware version. The firmware can be checked and updated using PumpScanner.

Check whether the latest version of PumpScanner is installed on your android device. Check the PumpScanner manual for help.

1. Make sure that the physical installation is completed and that all connections have been double checked for correct connection.
2. Connect the power to the PS2 controller but leave the ON/OFF toggle switch of the PS controller in position OFF. The pump must not run at this point.
3. Connect to the pump controller using PumpScanner as per the PumpScanner manual.
4. Check the PS2 controller Firmware version as per the PumpScanner manual and update it if asked by PumpScanner to do so.
5. Click on "Pump profile" in PumpScanner to access the parameter settings for the PS2 controller. Do not forget to scroll to the bottom and **SAVE the changes** before leaving the "pump profile" menu.

Controller and pump unit – Use the pull down menu to select the correct controller and the correct pump unit.

Cable length and cable size – Enter the length and size of the installed motor cable to allow PumpScanner to calculate the correct cable losses for the pump system.

Flow meter and pressure sensor – If any Water Meter or Pressure Sensor is connected to the PS2 controller enter the characteristics of the sensors as described.

The remaining options are explained in the PumpScanner manual.

Always click the **SAVE Button** on the bottom of the pump profile menu to keep the changes.

The pump profile configuration is done and the pump can be switched ON.

11 PumpScanner / CONNECTED

The LORENTZ CONNECTED portfolio takes water pumping to the next level. It offers a range of features for monitoring and managing pumps, even remotely over the internet. CONNECTED - a new water pumping experience.

11.1 PumpScanner

PumpScanner allows you and your customers to monitor and manage your PS2 solar pump system from a smartphone or tablet.

PumpScanner is used as the programming interface and configuration tool for the pump system. Configuration of the pump system for data recording, configuration of sensors, speed control, timers and control by pressure, level or flow all require PumpScanner.

In addition to configuring the pump system, PumpScanner provides realtime performance data that can be used by the installer or the customer. The PS2 system will also store data for later analysis using PumpScanner.

PumpScanner can be downloaded from the Google Play store, search for LORENTZ PumpScanner. If you do not have access to a Play store in your country, please download the app from www.lorentz.de/psdl.

Further information on use of PumpScanner including detailed functions and installation are available in the PumpScanner manual on partnerNET under the Support > CONNECTED section.

11.2 Password Access

To allow easier access to PumpScanner functions for your customers we have added Password based access. Password access is enabled by default if the pump has not been configured by a LORENTZ partner. Password access can be disabled within password options when connected to a pump system.



WARNING – If you do not perform an initial configuration of the pump system using PumpScanner then unlimited access by password will be allowed.

Best practice is to change the default passwords at the time of pump installation and only to give appropriate password access to your customer.

Default passwords for the system are:

Username	Password
Admin	Admin
User	User
Guest	Guest

Password options are accessed by using the padlock icon when connected to a pump system.

Figure 30: Password access settings

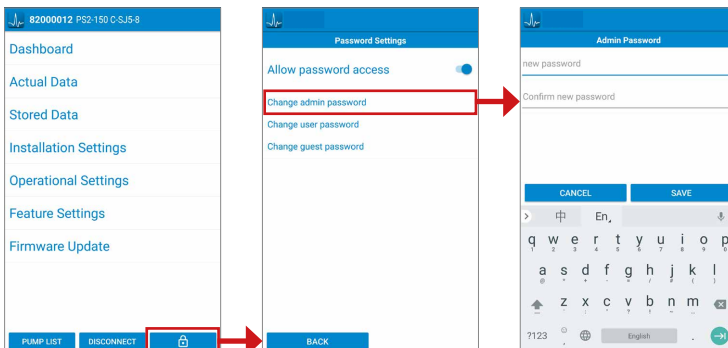

12 Troubleshooting

Please read this section carefully in case you experience any problems with the pump system and follow the checklists. Should technical support by LORENTZ become necessary, always provide the model and serial numbers.

12.1 Pump does not run

Most problems are caused by either wrong cable connections (in a new installation) or failed connections, especially insufficiently tightened cables that come loose from a terminal. Please check the wiring. The System status light will indicate that the system is switched on and a power source is connected to the controller. It indicates that voltage is present but in a solar-direct system there may not be sufficient power to start the pump. In this case it will attempt a restart every 120 seconds.

12.2 Pump attempts a Restart every 120 Seconds

The controller will emit a low noise as it tries to start the pump. The pump will start to turn or only vibrate a little.

- (1) There may be insufficient power reaching the controller. A solar-direct (non-battery) system should start if there is sufficient sun to cast a slight shadow. A battery system should start if the supply voltage is higher than what is listed in „Table 6: Set points for low voltage disconnect“ on page 29.
- (2) If the pump was recently connected (or reconnected) to the controller, it may be running in reverse direction due to a wiring error.
- (3) If the motor shaft only vibrates but does not turn, it may have power on only two of the three motor wires. This will happen if there is a broken connection or if you accidentally interchanged one of the power wires with the ground wire.
- (4) The pump or pipe may be blocked by mud, clay, sand or debris



CAUTION – if the pump is blocked, it has to be cleaned. Repeated starting of a blocked pump may cause damage to the motor. This will void the warranty.

12.3 Flow Rate is too low

Check if the pipeline dimensions are correct as pressure losses will reduce the flow. Ensure that there is no leakage in the pipeline.

12.4 General checklist

Check the PV generator

Make sure the PV generator is facing the sun and there is no partial shading of the array. A partial shading of as little as 10% of the arrays' surface can stop the pump.

Check all wires and connections

Carefully check for improper wiring (especially in a new installation) and wiring condition. Wires are often damaged by animals if they are not enclosed in conduit (pipe). Pull on wires slightly to check for failed connections.

Check the controller

- (1) Loosen the screws from the front of the controller to access the terminal block where the wires connect.
- (2) Check for a burnt smell. This will indicate a failure of the electronics. Look for burnt wires, bits of black debris, and any other signs of lightning damage.
- (3) Inspect the grounding wires and connections. Most controller failures are caused by an induced surge from nearby lightning where the system is not effectively grounded. Ground connections must be properly made and free of corrosion.

Check the dry running protection

If the controller indicates “source low” when the pump is submerged in water or draws from a sufficient water source, check the dry running protection system. The probe is mounted on, or near the pump. If inspection is not feasible, you can measure the well probe for continuity with a multimeter. The Well Probe should show continuity when it is submerged in the water.

Check the float switch

If the controller indicates “remote switch” when the storage tank is not full, inspect the float switch system. If your system has a float switch, it will be mounted in the tank. If inspection is not feasible, you can bypass the switch or test it electrically.

Force a quick start

If you restore a connection or bypass the probe or float switch, there is no need to wait for the normal time delay. Manually switch the on/off switch (or the power source) off and on to reset the system. The pump should start immediately if sufficient power is present.

If the pump responds to the bypass tests but not to the float switch, the wires may be shorted (touching each other) or open (broken) or the switch may be stuck with debris, or out of its correct position.

Quick checklist

Make sure

- (1) the pump is suited for the total lift that is required.
- (2) the “max. RPM” adjustment in PumpScanner is not the reason for perceived low pump performance.
- (3) the solar array is receiving sufficient sun light without shading on the modules, the PV generator is oriented properly and tilted at the correct angle. Inspect and test the PV generator circuit and the controller output, as stated. Take notes of your measurements.
- (4) all wires and pipe runs are sized adequately for the respective distance.
- (5) there is no leak in the output pipe from the pump.

Could the issue not be resolved, please raise a service case with LORENTZ including the service support forms available on partnerNET, model and serial numbers and your measurements.



Installation details

Site/System name/nom/nombre:	<input type="text"/>		
Pump setting in bore Profondeur de la pompe Profundidad de la bomba	<input type="text"/>	Number of Modules Nombre de panneaux Número de paneles	<input type="text"/>
Static head Perte de pression statique Altura estática	<input type="text"/>	Power / module (wp) Puissance / module (wp) Potencia / módulo (wp)	<input type="text"/>
Pipe length Longueur de canalisation Longitud de la tubería	<input type="text"/>	Total power (Wp) Puissance totale (Wp) Potencia total (Wp)	<input type="text"/>
Pipe size Diamètre du tuyau Tamaño del tubo	<input type="text"/>	Number of strings Nombre de strings Número de strings	<input type="text"/>
Water temperature Température de l'eau Temperatura del agua	<input type="text"/>		

Product labels

PS2 Controller

Pump end

Motor

Communicator SIM ID

Communicator

LORENTZ 

www.lorentz.de